

**CADDY**<sup>®</sup>

# Electrical and Low Voltage/ Datacomm Fasteners

2009

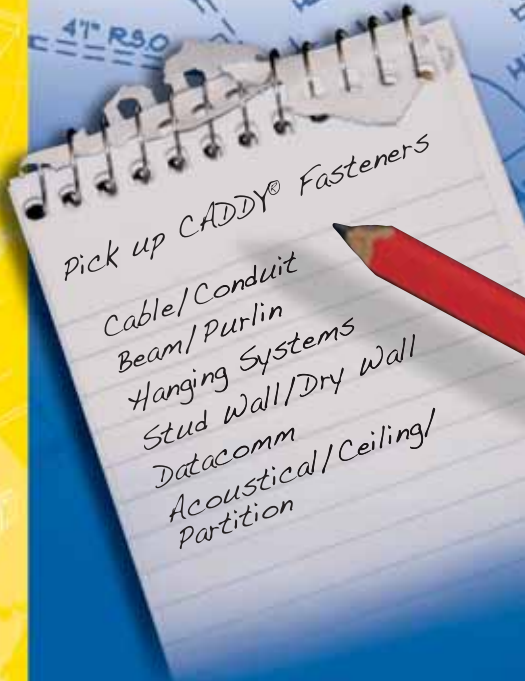













**ERICO**<sup>®</sup>



## **Innovation and Quality – The Cornerstones of Our Business**

For more than 100 years, ERICO® has built its reputation by developing and marketing high-quality, innovative products. As a trusted industry leader, our products and services are recognized for providing labor- and cost-saving solutions for customers throughout the world. As ERICO continues to maintain a strong focus on developing innovative, leading-edge products, we also support green building initiatives by producing products that incorporate recycled content to use less raw materials and minimize waste. It is our goal to continue to create high-quality, state-of-the-art products, while also providing the unparalleled service our customers have come to expect.

# Table of Contents

	New & Featured Products.....	5-10
	Cable/Conduit.....	11-42
	Beam/Purlin.....	43-64
	Strut.....	65-80
	Hangers/Hanging Systems .....	81-96
	Stud Wall.....	97-116
	Drywall .....	117-122
	Datacomm/ITS.....	123-154
	Acoustical/Ceiling/Partitions .....	155-172
	Miscellaneous .....	173-178
	Reference Information.....	179-182
	The CADDY® Fastener Story.....	183-186
	Index.....	187-194

As part of our ongoing commitment to innovation and quality, ERICO® is dedicated to minimizing the impact we place on our environment. This catalog is printed on paper made with post-consumer recycled fiber, which is one example of our pledge for environmental preservation. By printing on this recycled paper, we have saved:

- Over 44,000 lbs. of wood: A total of 152 trees that supply enough oxygen for 76 people annually.
- More than 55,000 gal. of water: Enough water to take 3,236 eight-minute showers.
- Over 100 min. BTUs of energy: Enough energy to power an average American household for 426 days.
- More than 13,000 lbs. of emissions: Carbon sequestered by 161 tree seedlings grown for 10 years.
- More than 7,000 lbs. of solid waste: A total of 246 thirty-two gallon garbage cans of waste

## Superior Corrosion Resistance

ERICO® is revolutionizing corrosion protection with CADDY ARMOUR. This innovative new corrosion protection system for steel parts is UL® Recognized and RoHS compliant. Testing conducted by independent testing facilities and ERICO has proven CADDY ARMOUR to be the most advanced, self-healing coating available, providing the highest level of corrosion resistance on the market.

## Excellent Coat Quality

CADDY ARMOUR provides an extremely consistent and even coating. This aesthetically pleasing appearance is particularly important for installations in highly visible areas, such as open ceilings.

Utilizing a state-of-the-art, computer-controlled process, the coating is applied consistently to each part, enabling up to 10 times greater corrosion resistance performance. Corrosion resistance is proven through the ASTM® B117/ DIN 50021 salt spray and GM 9540P Accelerated Cyclic Corrosion tests.



## HOT PRODUCTS



### CADDY® CAT LINKS

CADDY® CAT LINKS is the newest, most innovative J-Hook support solution from ERICO, the company that brought you the original CADDY® CABLECAT patented J-Hook.

CADDY CAT LINKS offers the largest family of J-Hook sizes on the market. The full range provides a bending radius that meets TIA standards for Cat 6a and easily accommodates Cat 7, large diameter optical fiber, innerduct and coaxial cable.

See for yourself how the versatile CADDY CAT LINKS can simplify your installations while saving time and labor.

# Featured Products



Beam Mounting Kit



Between T-grid Mounting Kit

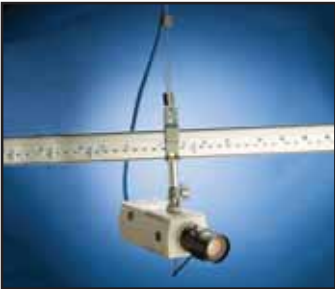

T-grid Mounting Kit



Wall Mounting Kit

## SECURITY CAMERA MOUNTING KITS

ERICO® understands that protecting your business is easy when you have the right tools. To simplify installation and enhance your security system, choose a mounting system that's easy to install, reliable and includes all of the necessary hardware.



# Featured Products



## CADDY® SPEED LINK

The CADDY® SPEED LINK Universal Support System is a cost-effective alternative to jack chain, threaded rod and associated hardware. This innovative system reduces installation time, inventory and shipping costs.

Consisting of all-steel construction, the CADDY SPEED LINK includes a strong, yet flexible wire rope with a specially engineered hook or toggle at one end, which serves as the means of support.

CADDY SPEED LINK can be installed without drilling and allows objects to be hung at a variety of angles – even from sloped ceilings.

# Featured Products



## CADDY® PYRAMID

CADDY PYRAMID Pipe & Equipment Supports from ERICO® provide an easy method for supporting pipes, conduit and equipment on roofs and below raised floors. CADDY PYRAMID dramatically reduces installation time by replacing other labor intensive support methods such as wood blocks, straps and clips. It also replaces steel foot plates, which can seriously damage roof membranes.

The support design consists of a foam block with a metal top. The polyethylene foam block absorbs shock and vibration but will not absorb water. The metal cover on top of the support offers protection from weather and other environmental conditions. The electro-galvanized finish on the cover offers corrosion protection.

CADDY PYRAMID provides for numerous mounting options and clamping positions. The foam and metal models offer mounting support up to 600 lbs. There is an all-plastic model available for loads up to 25 lbs.





# Featured Products



## EC311P

The EC311P Independent Electrical Drop Wire/Rod Securing Clip prevents the sway of dedicated electrical drop wire/rod. No tools are required for installation and the forgiving design eliminates the need for exact cutting of rod or wire.



## MCS

This support bracket for MC/AC cable neatly isolates, supports and secures MC/AC cables. It also properly spaces MC/AC cable to eliminate bundling and NEC and CEC derating issues.



## CCS812

The Floor Mounted Box/Conduit Support provides support for electrical boxes from floor or concrete forms. It is available in 12", 16" and 18" heights.



## TSGB

The TSGB Telescopic Screw Gun Bracket for between studs can mount multiple 1-1/2" or 2-1/8" deep boxes. It is notched and marked for easy identification and bending. The improved design with pilot holes allow easy box attachment with only a screwdriver.

# Featured Products



## **SBT18**

The Multiple Conduit Mounting Plate provides an easy, snap-in attachment of up to three conduit clips. It also provides automatic alignment with 1-1/2" electrical box knockouts and mounting holes.



## **FMBS18**

The Floor Mounted Box Support positions the center of the electrical box 18-1/2" above an unfinished floor. It mounts 4" or 4-11/16" U.S. or Canadian boxes that are 1-1/2" or 2-1/8" deep.



## **512HD**

The 512HD T-Grid Box Hanger can mount a box to T-grid in less than 30 seconds. It is also included in the Security Camera Mounting Kit for Dome Cameras and Sensors (SCMKC).



## **TDH**

Unlike screws, which are not load rated, the TDH Decking Hanger is fully rated to hang and support vertical loads from metal roof decking.



# Cable/Conduit



# Cable/Conduit

## Conduit Clips

### Features

- Spring steel M Clips have finger closure
- Spring steel P Clips have push-in installation
- Helps to guide alignment with electrical box knockouts.
- 9/32" plain hole or 1/4"-20 thread impression options for mounting and field assembly to structure fasteners



Fig. #1

Patent Number: 5,533,696

Part Number	Fig. #	Conduit Size (in)	Mounting Hole (in)	Standard Packaging Quantity
6M*	1	For 14-2 thru 12-3 MC/AC and 3/8 Flexible Conduit	9/32 Plain	100
812M*	1	1/2 to 3/4	9/32 Plain	100
16M*	1	1	9/32 Plain	100
20M*	1	1 1/4	9/32 Plain	100
24M*	1	1 1/2	9/32 Plain	100
32M*	1	2	9/32 Plain	100
812M4I*	1	1/2 to 3/4	1/4-20 Thread Impression	100
6M4I*	1	For 14-2 thru 12-3 MC/AC and 3/8 Flexible Conduit	1/4-20 Thread Impression	100
16M4I*	1	1	1/4-20 Thread Impression	100
20M4I*	1	1 1/4	1/4-20 Thread Impression	100
24M4I*	1	1 1/2	1/4-20 Thread Impression	100
32M4I*	1	2	1/4-20 Thread Impression	100
8P†	2	1/2	9/32 Plain	100
12P†	2	3/4	9/32 Plain	100
16P†	2	1	9/32 Plain	100
8P4I†	2	1/2	1/4-20 Thread Impression	100
12P4I†	2	3/4	1/4-20 Thread Impression	100
16P4I†	2	1	1/4-20 Thread Impression	100

\*M Series 100 lbs. Vertical • 25 lbs. Horizontal

†P Series 25 lbs. Vertical • 15 lbs. Horizontal



Fig. #2



## Combination Push-in Wall Clips



### Features

- Ideal for EMT support between wall studs with SGB/TSGB series brackets
- Quickly attaches pipe, conduit, MC/AC and tube to wall surfaces
- Just push in - there's no need to close the clip
- Reduces the need to stock multiple products
- Standoff design reduces conduit bending
- Helps to guide alignment with electrical box knockouts
- Low-profile design minimizes snag potential
- Secure with powder-actuated tools, self-tapping concrete anchors or screw guns
- Lightweight, one-piece design

Part Number	Description	Standard Packaging Quantity
WC812	Combination Push-in Wall Clip 1/2" and 3/4" EMT conduit 1/2" Rigid, IMC, PVC SCH 40 5/8" & 3/4" Copper Tube MC/AC .700 - .925 OD	100



# Cable/Conduit

## Conduit Clamps with Bolts

### Features

- Retained bolt and built-in nut means there are less parts to handle or drop. Bright zinc finish
- Combo Head bolt ready to work with any tool handy - Slotted, Hex, #3 Phillips and #2 Robertson
- Mounting hole size CD0 thru CD3 for 1/4" bolt. CD4 thru CD9 for 5/16" bolt. Available in 3/8" mounting hole for 1/2" - 2" pipe. To order add suffix 37 (i.e. CD2B37)
- Can be used in locations where EMT or rigid conduit is used
- Accommodates 1/2" thru 4" conduit



Part Number	Conduit Size - Rigid (in)	Conduit Size - EMT (in)	Standard Packaging Quantity
CD0B*	1/2	1/2	100
CD1B*	3/4	3/4	100
CD2B*	1	1	100
CD2.5B*	-	1 1/4	100
CD3B*	1 1/4	1 1/2	100
CD4B*	1 1/2	-	50
CD5B*	2	2	50
CD6B	2 1/2	2 1/2	25
CD7B	3	3	25
CD8B	3 1/2	3 1/2	10
CD9B	4	4	10

\*Manufactured with retained bolt and built-in nut

**Notes:** Also available in stainless steel 302. Contact ERICO® for price and delivery. To order add suffix SS (ie. CD2B-SS). Stainless do not have nutless feature

CD0B through CD5B are UL & cUL Listed and meet or exceed UL Test Requirements

See Beam/Purlin chapter for Assemblies (BC200 Series)

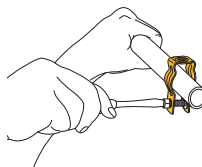

# Cable/Conduit

## Flange-Mount Conduit Clip

### Push-In

#### Features

- Requires only a hammer to install
- Available for 1/2" thru 1" EMT, rigid and aluminum conduit
- Available with conduit clip bottom mounted or side mounted
- Will pivot thru 360°



Fig. #1

Part Number	Fig. #	Description	Standard Packaging Quantity
8P24*	1	1/2" conduit to 1/8" to 1/4" flanges	100
8P58*	1	1/2" conduit to 5/16" to 1/2" flanges	100
8P912*	1	1/2" conduit to 9/16" to 3/4" flanges	100
12P24*	1	3/4" conduit to 1/8" to 1/4" flanges	100
12P58*	1	3/4" conduit to 5/16" to 1/2" flanges	100
12P912*	1	3/4" conduit to 9/16" to 3/4" flanges	100
16P24*	1	1" conduit to 1/8" to 1/4" flanges	100
16P58*	1	1" conduit to 5/16" to 1/2" flanges	100
16P912*	1	1" conduit to 9/16" to 3/4" flanges	50
8P24SM†	2	1/2" conduit to 1/8" to 1/4" flanges	100
8P58SM†	2	1/2" conduit to 5/16" to 1/2" flanges	100
8P912SM†	2	1/2" conduit to 9/16" to 3/4" flanges	100
12P24SM†	2	3/4" conduit to 1/8" to 1/4" flanges	100
12P58SM†	2	3/4" conduit to 5/16" to 1/2" flanges	100
12P912SM†	2	3/4" conduit to 9/16" to 3/4" flanges	100
16P24SM†	2	1" conduit to 1/8" to 1/4" flanges	100
16P58SM†	2	1" conduit to 5/16" to 1/2" flanges	100
16P912SM†	2	1" conduit to 9/16" to 3/4" flanges	50

\*Load Limit: 25 lbs

†Load Limit: 15 lbs

**Notes:** When using rigid conduit on P series, use next size larger clip (1/2" Rigid use 12P).; 'SM' suffix designates 'Sidemount' application

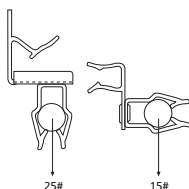

Indicated loads are static and should not be combined



Fig. #2



# Cable/Conduit

## Flange-Mount Conduit Clip

### Snap Close

#### Features

- Available with conduit clip bottom mounted or side mounted
- Available for 1/2" thru 1" EMT, rigid and aluminum conduit
- Requires only a hammer to install
- Will pivot thru 360°



Fig. #1

Part Number	Fig. #	Description	Standard Packaging Quantity
6M24*	1	3/8" MC/AC cable to 1/8" to 1/4" flanges	100
6M58*	1	3/8" MC/AC cable to 5/16" to 1/2" flanges	100
6M912*	1	3/8" MC/AC cable to 9/16" to 3/4" flanges	100
812M24*	1	1/2" or 3/4" Hammer-On Pipe Clip for Flanges 1/8" to 1/4"	100
812M58*	1	1/2" or 3/4" Hammer-On Pipe Clip for Flanges 5/16" to 1/2"	100
812M912*	1	1/2" or 3/4" Hammer-On Pipe Clip for Flanges 9/16" to 3/4"	100
16M24*	1	1" Hammer-On Pipe Clip for Flanges 1/8" to 1/4"	100
16M58*	1	1" Hammer-On Pipe Clip for Flanges 5/16" to 1/2"	100
16M912*	1	1" Hammer-On Pipe Clip for Flanges 9/16" to 3/4"	100
20M24*	1	1-1/4" Hammer-On Pipe Clip for Flanges 1/8" to 1/4"	100
20M58*	1	1-1/4" Hammer-On Pipe Clip for Flanges 5/16" to 1/2"	100
20M912*	1	1-1/4" Hammer-On Pipe Clip for Flanges 9/16" to 3/4"	50
24M24*	1	1-1/2" Hammer-On Pipe Clip for Flanges 1/8" to 1/4"	50
24M58*	1	1-1/2" Hammer-On Pipe Clip for Flanges 5/16" to 1/2"	50
24M912*	1	1-1/2" Hammer-On Pipe Clip for Flanges 9/16" to 3/4"	50
32M24*	1	2" Hammer-On Pipe Clip for Flanges 1/8" to 1/4"	50
32M58*	1	2" Hammer-On Pipe Clip for Flanges 5/16" to 1/2"	50
32M912*	1	2" Hammer-On Pipe Clip for Flanges 9/16" to 3/4"	50





# Cable/Conduit



Fig. #2

Part Number	Fig. #	Description	Standard Packaging Quantity
6M24SM†	2	3/8" MC/AC cable to 1/8" to 1/4" flanges (Sidemount)	100
6M58SM†	2	3/8" MC/AC cable to 5/16" to 1/2" flanges (Sidemount)	100
6M912SM†	2	3/8" MC/AC cable to 9/16" to 3/4" flanges (Sidemount)	100
812M24SM†	2	1/2" to 3/4" conduit to 1/8" to 1/4" flanges (Sidemount)	100
812M58SM†	2	1/2" to 3/4" conduit to 5/16" to 1/2" flanges (Sidemount)	100
812M912SM†	2	1/2" to 3/4" conduit to 9/16" to 3/4" flanges (Sidemount)	100
16M24SM†	2	1" conduit to 1/8" to 1/4" flanges (Sidemount)	100
16M58SM†	2	1" conduit to 5/16" to 1/2" flanges (Sidemount)	100
16M912SM†	2	1" conduit to 9/16" to 3/4" flanges (Sidemount)	100
20M24SM†	2	1 1/4" conduit to 1/8" to 1/4" flanges (Sidemount)	100
20M58SM†	2	1 1/4" conduit to 5/16" to 1/2" flanges (Sidemount)	100
20M912SM†	2	1 1/4" conduit to 9/16" to 3/4" flanges (Sidemount)	50
24M24SM†	2	1 1/2" conduit to 1/8" to 1/4" flanges (Sidemount)	50
24M58SM†	2	1 1/2" conduit to 5/16" to 1/2" flanges (Sidemount)	50
24M912SM†	2	1 1/2" conduit to 9/16" to 3/4" flanges (Sidemount)	50
32M24SM†	2	2" conduit to 1/8" to 1/4" flanges (Sidemount)	50
32M58SM†	2	2" conduit to 5/16" to 1/2" flanges (Sidemount)	50
32M912SM†	2	2" conduit to 9/16" to 3/4" flanges (Sidemount)	50

\*Load Limit: 75 lbs

†Load Limit: 25 lbs

# Cable/Conduit

## Conduit Hangers

From Flange, Wire or Plain Rod

### Features

- Supports conduit (EMT, Rigid, ENT, MC/AC and Aluminum) to rods\* or flanges
- Can also be used for: flexible metallic tubing, armored cable, portable cables, control tubes, communications cable, etc
- No installation tools required



Fig. #1

CONDUIT SIZE	#10 & #12 WIRE	#8 & #9 WIRE	3/16" & 1/4" ROD*	1/8"-1/4" FLANGE	5/16"-3/8" FLANGE	7/16"-1/2" FLANGE
1/2" EMT	K8	K8	K8	K8	K12	K12
1/2" RIGID	K8	K12	K12	K12	K12	K16
3/4" EMT	K12	K12	K12	K12	K16	K16
3/4" RIGID	K12	K12	K16	K16	K20**	K20**
1" EMT	—	K16	K16	K16	K20**	K20**
1" RIGID	—	—	—	K20**	K20**	K20**
1 1/4" EMT	—	K20	K20	K20	—	—

\*\*K Series packaged 100 per box. KX - No load rating - positioning

CABLE SIZE	WIRE SIZES		Standard Packing Quantity
	#12	#10, #9, #8	
14-2 (.433-.475 O.D.)	KX	KX	100
14-3 (.453-.500 O.D.)	KX	KX	100
12-2(.467-.510 O.D.)	KX	KX	100
12-3 (.489-.535 O.D.)	KX	K8	100



# Cable/Conduit



Fig. #2

The original “Bat Wings” in 1959

Part Number	Fig. #	Description	Standard Packaging Quantity
KX	1	Conduit hanger MC/AC or BX to #8 wire	100
K8	2	Conduit hanger 1/2" EMT to 1/4" and smaller rods or flanges	100
K12	2	Conduit hanger 3/4" EMT to 1/4" and smaller rods or flanges	100
K16	2	Conduit hanger 1" EMT to 1/4" and smaller rods or flanges	100
K20	2	Conduit hanger 1-1/4" EMT to 1/4" and smaller rods or flanges	100

**Notes:** May require dedicated drop wire/rod and EC311 – Consult local authority

For horizontal application only when using plain rods.

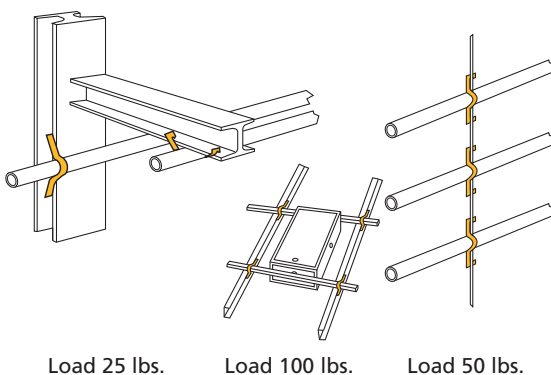

# Cable/Conduit

## Cable/Conduit From Drop Wire Support

### Features

- Supports cable and conduit without bending drop wire
- Faster installation than traditional methods



Fig. #1

Ultimate Static Load: 25 lbs.

Part Number	Fig. #	Description	Standard Packaging Quantity
PCS1	1	Flexible cable support from #8-#12 drop wire for MC/AC 14-2 through 12-3 with ground up to .600 O.D.	100
PCS2	2	Conduit/cable support from #8-#12 drop wire for 1/2" and 3/4" EMT, MC/AC up to .900 O.D.	100

**Notes:** May require dedicated drop wire/rod and EC311 – Consult local authority



Fig. #2



# Cable/Conduit

## Multi-Function Clip

From Drop Wire, Plain Threaded Rod, or Flange

### Features

- Attaches to #12 wire thru 3/8" rod
- Fits 1/8" to 3/8" flanges
- Provides attachment of conduit and boxes
- Supports #10-24 and 1/4-20 threaded bridle rings
- Supports 4" or 4-11/16" electrical box



Fig. #1



Part Number	Fig. #	Description	Wire/Rod Size (in)
4Z34	1	Multi-function clip	#12 wire - 1/4"
4Z45	2	Multi-function clip with 1/4-20 stud and hex nut	#12 wire - 1/4"
4Z34812M	3	Multi-plus 1/2" or 3/4" conduit	#12 wire - 1/4"
4Z3416M	3	Multi-plus 1" conduit	#12 wire - 1/4"
4Z348P*	4	Multi-plus 1/2" EMT conduit	#12 wire - 1/4"
4Z3412P*	4	Multi-plus 3/4" EMT conduit	#12 wire - 1/4"
4Z3416P*	4	Multi-plus 1" EMT conduit	#12 wire - 1/4"
6Z34	1	Multi-function clip	3/8" rod
6Z45	2	Multi-function clip	3/8" rod
6Z34812M	3	Multi-plus 1/2" or 3/4" conduit	3/8" rod
6Z3416M	3	Multi-plus 1" conduit	3/8" rod
6Z348P*	4	Multi-plus 1/2" EMT conduit	3/8" rod
6Z3412P*	4	Multi-plus 3/4" EMT conduit	3/8" rod
6Z3416P*	4	Multi-plus 1" EMT conduit	3/8" rod

\*When using rigid conduit on P-Series, use next size larger clip (1/2" Rigid use 12P)

**Standard Packaging Quantity:** 100

**Notes:** May require dedicated drop wire/rod and EC311 – Consult local authority

When using rigid conduit on P series, use next size larger clip (1/2" Rigid use 12P)

4Z series designates 1/8"-3/8" Flange Size

6Z series designates 3/8"-7/16" Flange Size



Fig. #2



Fig. #3



Fig. #4

# Cable/Conduit

## Conduit to Conduit

### Features

- Available for conduit 1/2" to 1" EMT and 1/2" to 3/4" Rigid
- Ideal as spacer between same or different size conduit
- No tools required for installation
- Top conduit to be used for support only, not a raceway



Ultimate Static Load: 25 lbs

Part Number	Description	Conduit Size (in)	Standard Packaging Quantity
8P8P	1/2" Conduit to 1/2" conduit	1/2 to 1/2	100
8P12P	1/2" Conduit to 3/4" conduit	1/2 to 3/4	100
8P16P	1/2" Conduit to 1" conduit	1/2 to 1	50
12P12P	3/4"-3/4" Conduit to conduit	3/4 to 3/4	100
12P16P	3/4"-1" Conduit to conduit	3/4 to 1	100
16P16P	1" Conduit to 1" conduit	1 to 1	50

**Notes:** When using rigid conduit on P series, use next size larger clip (1/2" Rigid use 12P).

## Lightweight Trapeze

### Features

- Fast, easy assembly for lightweight loads up to 100 lbs
- Use with 3/8" MC/AC to 2" conduit
- No screws or bolts required



Part Number	Description	Load Limit (lbs)	Standard Packaging Quantity
166M	14-2 thru 12-3 MC/AC to 1" Conduit	100	100
16812M	1/2" or 3/4" Conduit to 1" Conduit	100	100
1616M	1" Conduit to 1" Conduit	100	100
1620M	1 1/4" Conduit to 1" Conduit	100	50
1624M	1 1/2" Conduit to 1" Conduit	100	50
1632M	2" Conduit to 1" Conduit	100	50

**Notes:** Total load of trapeze must not exceed 100 lbs.

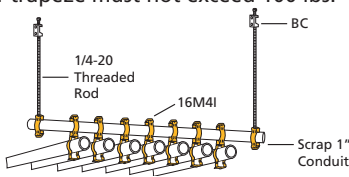

# Cable/Conduit

## One-Piece Strut Clamp

### SCH Series

#### Features

- One-piece installation – no screws or bolts to drop
- Installs quickly and easily. Requires only a screwdriver or nut driver for installation
- Heavy-duty construction with a bright zinc finish
- Size 3/8" MC/AC to 4" EMT conduit
- All sizes available with load distribution plate attached to screw
- Surface finish: electro zinc plated



Fig. #2



Part Number	Fig. #	EMT (in)	Rigid (in)	Cable OD (in)	Static Load (lbs)	Standard Packaging Quantity
SCH8	1	1/2	-	-	200	100
SCH12	1	3/4	1/2	-	200	100
SCH16	1	1	3/4	-	200	100
SCH20	1	1 1/4	1	-	200	100
SCH6B	2	3/8	-	0.100 - 0.630	200	100
SCH8B	2	1/2	-	0.340 - 0.710	200	100
SCH12B	2	3/4	1/2	0.570 - 0.920	200	100
SCH16B	2	1	3/4	0.720 - 1.160	200	100
SCH20B	2	1 1/4	1	1.000 - 1.510	200	100
SCH24B	2	1 1/2	1 1/4	1.250 - 1.750	350	50
SCH32B	2	2	1 1/2	1.740 - 2.200	350	50
SCH40B	3	-	2	2.000 - 2.380	350	25
SCH48B	3	2 1/2	2 1/2	2.380 - 2.880	350	25
SCH56B	3	3	3	2.720 - 3.500	350	25
SCH64B	3	3 1/2	3 1/2	3.250 - 4.000	350	10
SCH72B	3	4	4	3.850 - 4.500	350	10



Fig. #1



Fig. #3



# Cable/Conduit

## Universal One-Piece Strut Clamp

### SK Series

#### Features

- One-piece construction
- Retained bolt and built-in nut prevents dropping of loose parts
- One size fits EMT and Rigid
- Installs with screwdriver, standard wrench or nut driver
- Break in half and install
- Bright zinc finish
- Works with standard 1 5/8" Strut



Fig. #1



Fig. #2

Part Number	Fig. #	EMT Rigid (in)	Standard Packaging Quantity
<b>Mild Steel - Static Load 200 lbs</b>			
SK125I	1	3/4	100
SK165I	1	1	100
SK205I	1	1 1/4	100
SK245I	1	1 1/2	50
SK325I	1	2	50
SK85I	1	1/2	100
<b>Mild Steel - Static Load 350 lbs</b>			
SK405I	2	2 1/2	50
SK485I	2	3	50
SK565I	2	3 1/2	25
SK645I	2	4	25
<b>Aluminum - Static Load 150 lbs</b>			
SK12ALA*	1	3/4	100
SK16ALA*	1	1	100
SK20ALA*	1	1 1/4	100
SK24ALA*	1	1 1/2	50
SK32ALA*	1	2	50
SK8ALA*	1	1/2	100
<b>Aluminum - Static Load 200 lbs</b>			
SK40ALA*	2	2 1/2	50
SK48ALA*	2	3	50
SK56ALA*	2	3 1/2	25
SK64ALA*	2	4	25



\*Aluminum SKs do not have a thread impression. An aluminum nut and bolt are provided. Order with no "A" on end for standard steel bolt and nut.





# Cable/Conduit

## Rigid Pipe Clamp One-Piece



### Features

- Supports rigid pipe to strut
- Handles heavy loads
- One -piece design incorporates a retained bolt and built-in nut
- Installs with either a screwdriver or a nut driver
- Complete line is available to fit a wide range of pipe sizes
- Available in various materials and finishes

Part Number	Pipe Size (in)		Load (lbs)	Standard Packaging Quantity
	Nominal	O.D.		
RIGD0050XX	1/2	0.840	400	100
RIGD0075XX	3/4	1.050	400	100
RIGD0100XX	1	1.315	600	100
RIGD0125XX	2 3/4	1.660	600	50
RIGD0150XX	5 1/2	1.900	800	50
RIGD0200XX	2	2 3/8	800	50
RIGD0250XX	10 1/2	2 7/8	800	25
RIGD0300XX	3	3 1/2	800	25
RIGD0350XX	15 1/2	4	1,000	25
RIGD0400XX	4	4 1/2	1,000	25

**Notes:** XX denotes finish available:

EG - Electro-Galvanized, CG - Yellow Chromate,

S4 - Stainless 304, S6 - Stainless 316,

HD - Hot Dipped Galvanized, AL - Aluminum.



# Cable/Conduit

## Snap-In Support

### MC/AC Cable Flexible Conduit

#### Features

- Manufactured with stabilizer legs for virtually “wobble-free” support
- One fastener for cable size 14-4, 12-4, 12-3, 12-2, 10-3, 10-2
- Snaps into place on metal stud and beam flange up to 1/8” thick. No tools required for installation
- MAC2 snaps in half to accommodate single run of cable effectively making two clips from one
- Prepunched holes in clip allow it to be screwed to wood stud, concrete or block
- Delivers compliance for: NEC® Article 300.4(d) allowing cable to be positioned a minimum of 11/4” from face of stud. CEC Rule 12-618 for support of MC/AC cable
- Factory riveted assemblies are available for installation on flange, purlin, acoustical tee, drop wire, concrete, block or wood and metal stud



Fig. #1



Part Number	Fig. #	Description	Standard Packaging Quantity
<b>Runs of MC/AC: 1 to 4</b>			
MAC2T	1	1 to 4 runs for metal stud	100
<b>Runs of MC/AC: 1 to 2</b>			
MAC2	2	Metal or wood stud and up to 1/8” flange	100
MAC2ATA	3	Acoustical Tee	100
MAC2BC	4	1/8” thru 1/2” flange	100
MAC2245M	5	1/8” thru 1/4” flange	100
MAC2585M	5	5/16” thru 1/2” flange	100
MAC29125M	5	1/16” thru 3/4” flange	100
MAC2VF14	6	1/16” thru 1/4” C purlin or vertical flange	100
MAC2123	7	Z Purlin	100
MAC2AO	8	Offset bracket	100
MAC224	9	1/8” thru 1/4” flange – bottom mount rotates 360°	100
MAC258	9	5/16” thru 1/2” flange – bottom mount rotates 360°	100
MAC2912	9	1/2” thru 3/4” flange – bottom mount rotates 360°	100
MAC24Z34	10	#12 thru 1/4” wire, plain or threaded rod & 1/8” thru 3/8” flange	100
MAC26Z34	10	3/8” plain or threaded rod and 3/8” thru 9/16” flange	100
MAC2FB	11	Through metal stud	100



**Notes:** Assemblies allow for support from most main and substructures.

# Cable/Conduit



Fig. #2



Fig. #3



Fig. #4



Fig. #5



Fig. #6



Fig. #7



Fig. #8



Fig. #9



Fig. #10



Fig. #11

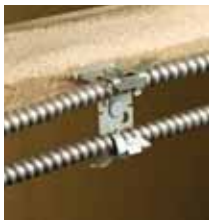

# Cable/Conduit

## Romex® Clip

### RMX SERIES

#### Features

- Supports non-metallic cable
- When used in combination with other CADDY® Fasteners, RMX can be installed on main or substructures, drop wire and acoustical tee



Fig. #1

Part Number	Fig. #	Cable Size	Description	Standard Packaging Quantity
RMX	1	14-2 and 12-2 w/ Ground Wire	Clip for Romex or Non-Metallic Cable	100
RMXDH2	2	14-2 and 12-2 w/ Ground Wire	Romex or Non-Metallic Cable to Deck	100
RMXAB	3	14-2 and 12-2 w/ Ground Wire	Romex or Non-Metallic Cable to Angle Bracket	100
RMXAO	4	14-2 and 12-2 w/ Ground Wire	Romex or Non-Metallic Cable to Offset Bracket	100
RMXVF14	5	14-2 and 12-2 w/ Ground Wire	Romex or Non-Metallic Cable to C Purlin 1/16" to 1/4" Thick	100
RMXAF14	6	14-2 and 12-2 w/ Ground Wire	Romex or Non-Metallic Cable to Z Purlin 1/16" to 1/4" Thick	100
RMXBC	7	14-2 and 12-2 w/ Ground Wire	Romex or Non-Metallic Cable to Beam thru 1/2 Flange	100
RMX4Z34	8	14-2 and 12-2 w/ Ground Wire	Romex or Non-Metallic Cable to #12 Wire thru 1/4" Plain Rod or Beam 1/8" thru 3/8" Flange	100
RMX6Z34	8	14-2 and 12-2 w/ Ground Wire	Romex or Non-Metallic Cable 3/8" Plain or Threaded Rod 3/8" thru 7/16" Flange	100
RMXATS	9	14-2 and 12-2 w/ Ground Wire	Romex or Non-Metallic Cable to Acoustical "Tee-Bar"	100
RMX24	10	1/8"-1/4" Thick Flange	14-2 and 12-2 with Ground Wire; Romex or Non-Metallic Cable to Beam	100
RMX58	10	5/16"-1/2" Thick Flange	14-2 and 12-2 with Ground Wire; Romex or Non-Metallic Cable to Beam	100
RMX912	10	9/16"-3/4" Thick Flange	14-2 and 12-2 with Ground Wire; Romex or Non-Metallic Cable to Beam	100

**Notes:** Not for use in Canada on NMC wire or power application; Assemblies allow support from most main and substructures



# Cable/Conduit

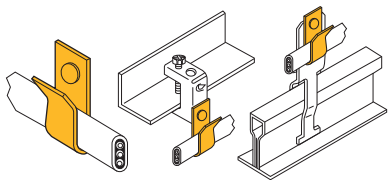

Assemblies allow support from most main and substructures



Fig. #2



Fig. #3



Fig. #4



Fig. #5



Fig. #6



Fig. #7



Fig. #8



Fig. #9



Fig. #10

Romex® is a registered trademark of General Cable Corp.

Ph: 1-800-25-CADDY®  
www.ericco.com

# Cable/Conduit

## Combination Box/ Conduit Hangers From Drop Wire/ Rod And Beam

### B18 Series

#### Features

- One riveted assembly
- No conduit bends (beam application)
- 66% less Drop Wires (rod/wire application)
- Delivers with NEC® & CEC compliance



Fig. #1



Fig. #2

Part Number	Fig. #	Description	Standard Packaging Quantity
812MB18	1	MOUNTS 4" SQ. BOXES WITH 1/2" & 3/4" conduit from #12 wire thru 1/4" rod	25
812MB186	1	MOUNTS 4" SQ. BOXES WITH 1/2" & 3/4" conduit from #12 wire thru 1/4" rod	25
16MB18	1	MOUNTS 4" SQ. BOXES WITH 1" conduit from #12 wire thru 1/4" rod	25
16MB186	1	MOUNTS 4" SQ. BOXES WITH 1" conduit to 3/8" plain or threaded rod	25
6MB18	1	MOUNTS 4" SQ. BOXES WITH MC, AC cable from #12 wire thru 1/4" flange	25
6MB186	1	MOUNTS 4" SQ. BOXES WITH MC, AC cable 3/8" plain or threaded rod	25
812MB18A	1	1/2" or 3/4" Conduit plain center hole for screw or threaded rod mount	25
16MB18A	1	MOUNTS 4" SQ. BOXES WITH 1" conduit plain center hole for screw or threaded rod mount	25
6MB18A	1	MOUNTS 4" SQ. BOXES WITH MC, AC cable plain center hole for screw or threaded rod mount	25
812MB18S	1	MOUNTS 4" SQ. BOXES WITH 1/2" & 3/4" conduit with 1/4-20 x 9/16" stud in center hole	25
812MB1824	2	MOUNTS 4" SQ. BOXES WITH 1/2" & 3/4" conduit to 1/8" thru 1/4" flange	25
812MB1858	2	MOUNTS 4" SQ. BOXES WITH 1/2" & 3/4" conduit to 5/16" thru 1/2" flange	25
16MB1824	2	MOUNTS 4" SQ. BOXES WITH 1" conduit to 1/8" thru 1/4" flange	25
16MB1858	2	MOUNTS 4" SQ. BOXES WITH 1" conduit to 5/16" thru 1/2" flange	25
6MB1824	2	MOUNTS 4" SQ. BOXES WITH MC, AC cable 1/8" thru 1/4" flange	25
6MB1858	2	MOUNTS 4" SQ. BOXES WITH MC, AC cable 5/16" thru 1/2" flange	25

Add "CO" at the end of the part number, for factory riveted assembly for multiple conduit clips. Includes mounting plate and center conduit clips pre-riveted (additional conduit clips ordered separately).

**Notes:** May require dedicated drop wire/rod and EC311 – Consult local authority. For single and multiple runs of conduit; UL & cUL Listed Box and Conduit Support



## Washer Wing Nut

### Features

- No tools required for installation



Part Number	Description	Static Load	Stud Length	Standard Packaging Quantity
4WN	1/4-20 thread impression washer wing nut	-	-	100

**Note:** 4WN: Not to exceed the load rating of the corresponding fastener

## Hammer-On Plain and Threaded Rod Hangers

### Beam Clamps

### Features

- Requires only a hammer to install
- Used to suspend #8 wire, 1/4", 3/8" plain rod or 1/4" or 3/8" threaded rod from beam flanges 1/8" to 3/4" thick



**Static Load:** 200 lbs

Part Number	Flange Thickness (in)	Rod Size	Standard Packaging Quantity
4TI58	5/16 to 1/2	1/4-20	100
6TI24	1/8 to 1/4	3/8-16	100
6TI58	5/16 to 1/2	3/8-16	100
6TI912	9/16 to 3/4	3/8-16	100



# Cable/Conduit

## Cable Snap Clip

### Features

- Supports cable from 1/16" - 1/2" flange
- Works effectively with MC and AC cable dimensions 3/8" - 1 1/4" and low voltage cables from 7/32" and up
- Clip "snaps" on flange and cable "snaps" into clip.



Part Number	Cable O.D. (in)	Description	Standard Packaging Quantity
SC2A	0.218 - 0.281	Low voltage, data and MC/AC cable to 1/16" thru 3/16" flange thickness	100
SC2B	0.312 - 0.375		100
SC2C	0.375 - 0.437		100
SC2D	0.468 - 0.562		100
SC2E	0.500 - 0.718		100
SC2F	0.750 - 0.937		100
SC2G	0.968 - 1.250		100
SC4A	0.218 - 0.281	Low voltage, data and MC/AC cable to 3/16" thru 9/32" flange thickness	100
SC4B	0.312 - 0.375		100
SC4C	0.375 - 0.437		100
SC4D	0.468 - 0.562		100
SC4E	0.500 - 0.718		100
SC4F	0.750 - 0.937		100
SC4G	0.968 - 1.250		100
SC8A	0.218 - 0.281	Low voltage, data and MC/AC cable to 5/16" thru 1/2" flange thickness	100
SC8B	0.312 - 0.375		100
SC8C	0.375 - 0.437		100
SC8D	0.468 - 0.562		100
SC8E	0.500 - 0.718		100
SC8F	0.750 - 0.937		100
SC8G	0.968 - 1.250		100

**Notes:** No load rating - positioning only





# Cable/Conduit

## MC/AC Cable To Metal Stud

### Features

- Easily attaches MC or AC to metal stud
- No tools required for installation
- Provides fast installation



Part Number	Cable Size	Standard Packaging Quantity
449	12-2 (.467-.510 O.D.) 12-3 (.489-.535 O.D.) 14-2 (.433-.475 O.D.) 14-3 (.453-.500 O.D.)	100

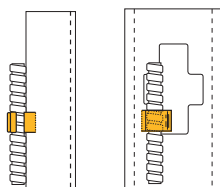

## Flexible Conduit and Cable Hanger

### Features

- Bundle runs\* of MC or AC. (\*Refer to local authorities and NEC® Article 310 for derating ampacity when flexible power cables are used)
- Can be used with 4H series flange clips, DH2 / TDH deck clips, AO or AB nail brackets, VF14 vertical flange, AF14/122/123 Z purlin



Part Number	Description	Runs of MC/AC	Ultimate Static Load (lbs)	Standard Packaging Quantity
WMX3	Cable hanger - 1 1/8" diameter	3	50	100
WMX6	Cable hanger - 1 3/4" diameter	6	75	100

Notes: Ultimate static load limit 75 lbs. - WMX6, 50 lbs. - WMX3



## Support Bracket for MC/AC Cable MCS Series

### Features

- Neatly isolates, supports and secures MC/AC cables
- Properly spaces MC/AC cable to help eliminate bundling and NEC® & CEC derating issues
- Results in a “neat and workmanlike” installation
- Reduces inventory
- Holds up to eight MC/AC cables
- cULus® Listed support



Fig. #1

Part Number	Fig. #	Description	Standard Packaging Quantity
<b>Pre-Riveted Factory Assemblies for MCS50</b>			
MCS50*	1	MC/AC cable support spacer for up to 4 runs	50
MCS5024	2	To beams 1/8"-1/4" flange thickness (Hammer-On)	25
MCS504Z	3	To #12 wire thru 1/4" plain or threaded rod	25
MCS5058	2	To beams 5/16"-1/2" flange thickness (Hammer-On)	25
MCS506Z	3	To 3/8" plain or threaded rod	25
MCS50912	2	To beams 9/16"-3/4" flange thickness (Hammer-On)	25
MCS50AF14	4	Z Purlin	25
MCS50BC	5	To beams thru 1/2" flange thickness (Screw-On)	25
MCS50BC200	6	To beams 1/8"-5/8" flange thickness (Screw-On)	25
MCS50VF14	7	C Purlin or Open Bar Joist	25
<b>Pre-Riveted Factory Assemblies for MCS100</b>			
MCS100*	8	Support bracket #12/14 AC up to 8 cables	50
MCS10024	2	To beams 1/8"-1/4" flange thickness (Hammer-On)	25
MCS1004Z	3	To #12 wire thru 1/4" plain or threaded rod	25
MCS10058	2	To beams 5/16"-1/2" flange thickness (Hammer-On)	25
MCS1006Z	3	To 3/8" plain or threaded rod	25
MCS100912	2	To beams 9/16"-3/4" flange thickness (Hammer-On)	25
MCS100AF14	4	Z Purlin	25
MCS100BC	5	To beams thru 1/2" flange thickness (Screw-On)	25
MCS100BC200	6	To beams 1/8"-5/8" flange thickness (Screw-On)	25
MCS100VF14	7	C Purlin or Open Bar Joist	25
<b>Pre-Riveted Factory Assemblies for MCS101</b>			
MCS101*	9	MC/AC cable† support spacer for up to 7 runs	50
MCS10124	2	To beams 1/8"-1/4" flange thickness (Hammer-On)	25
MCS1014Z	3	To #12 wire thru 1/4" plain or threaded rod	25
MCS10158	2	To beams 5/16"-1/2" flange thickness (Hammer-On)	25
MCS1016Z	3	To 3/8" plain or threaded rod	25
MCS101912	2	To beams 9/16"-3/4" flange thickness (Hammer-On)	25
MCS101AF14	4	Z Purlin	25
MCS101BC	5	To beams thru 1/2" flange thickness (Screw-On)	25
MCS101BC200	6	To beams 1/8"-5/8" flange thickness (Screw-On)	25
MCS101VF14	7	C Purlin or Open Bar Joist	25

\*Nominal outside diameters from .430 thru .560. 14-3, 14-4, 12-2, 12-4 and 10-2 MC/AC Cable

†Nominal outside diameters from .560 thru .690. Standard MC sizes: 10/3, 10/4, \*8/2, \*8/3. Super Neutral Cable: 12/3, 12/4 and \*10/2. Isolated Ground: 12/3, 12/4, 10/2, 10/3, 10/4 and 8/2.



# Cable/Conduit



Fig. #2



Fig. #3



Fig. #4



Fig. #5



Fig. #6



Fig. #7



Fig. #8



Fig. #9



## Multiple Conduit Mounting Plate

### SBT18

#### Features

- Single point structure attachment and easy “snap-in” field assembly of up to three conduit clips
- No tools necessary for installation of clips
- Helps eliminate conduit bends for 1/2” and 3/4” sizes
- Available in a variety of riveted assemblies
- Helps eliminate multiple beam clamps or strut assemblies
- Helps guide alignment with standard 1/2” electrical box knockouts and mounting holes



Fig. #1

Part Number	Fig. #	Description	Load Rating Per Tab (lbs)	Standard Packaging Quantity
SBT18	1	Multi-Run, Conduit Hanger Plate	50	50
SBT1824	2	Hammer-on; underside 1/8"-1/4" flange	25	50
SBT1858	2	Hammer-on; underside 5/16"-1/2" flange	25	50
SBT18912	2	Hammer-on; underside 9/16"-3/4" flange	25	50
SBT1824SM	3	Hammer-on; side mount 1/8"-1/4" flange	50	50
SBT1858SM	3	Hammer-on; side mount 5/16"-1/2" flange	50	50
SBT18912SM	3	Hammer-on; side mount 9/16"-3/4" flange	50	50
SBT184Z34	4	Multi-function clip #12 wire thru 1/4" plain rod	15	50
SBT186Z34	4	Multi-function clip 3/8" plain or threaded rod	15	50
SBT18BC	5	Beam clamp thru 1/2" flange	25	50
SBT18BC200	6	Beam clamp 1/8" to 5/8" flanges	33	50



# Cable/Conduit



Fig. #2



Fig. #3



Fig. #4



Fig. #5



Fig. #6



# Cable/Conduit

## CADDY® PYRAMID 25

### Pipe & Equipment Supports

#### Features

- Supports up to 25 lb loads
- Lightweight, all-plastic construction weighs less than 0,15 kg
- Has a small – 4" x 5" footprint
- UV-resistant, designed and tested for outdoor use
- Handles up to three 1/2" (21,3 mm) or two 3/4" (26,9 mm) or one 1" (33,7 mm) pipes/conduit
- No tools or fasteners needed for installation
- Helps protect the roof membrane

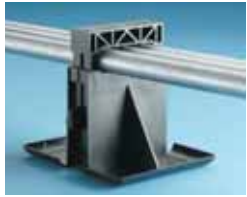

Part Number	Max. Working Load (lbs)	Height (in)
PPRPS25H4	25	3 5/8
PPRPS25H6	25	5 5/8

## CADDY® PYRAMID 50

### Pipe & Equipment Supports

#### Features

- Supports up to 50 lb loads
- Polyethylene closed-cell foam and 1,5 mm steel construction.
- The 4" high model has a 10-3/8" x 4" footprint
- The 6" high model has a 10-3/8" x 4-3/4" footprint
- Electro-galvanized (EG) finish on the rooftop version and grey polyester coating on the plenum version provide superior corrosion protection
- Metal top designed to shed water and minimize water collection on foam base
- Helps protect the roof membrane



Part Number	Max. Working Load (lbs)	Height (in)	Surface Finish
RPS50AHGP	50	2 1/4	Grey Polyester
RPS50H4EG	50	4	EG
RPS50H6EG	50	6	EG



# Cable/Conduit

## CADDY® PYRAMID 150

### Pipe & Equipment Supports

#### Features

- Supports up to 150 lb loads
- Has six 3/8"-16 threaded inserts with captive nuts that allows the product to be used with standard pipe clamps and accessories
- Large 16" x 12" footprint distributes load more evenly than alternative methods
- Polyethylene closed-cell foam and 14-gauge steel construction
- Electro-galvanized (EG) finish on top plate for added corrosion protection
- Helps protect the roof membrane



Part Number	Max. Working Load (lbs)	Height (in)	Thread Size	Surface Finish	With Strut
RPS150T1	150	3 3/16	3/8-16	EG	No
RPS150T2	150	4	3/8-16	EG	Yes

## CADDY® PYRAMID 300

### Pipe & Equipment Supports

#### Features

- Dramatically reduces installation time by replacing labor-intensive methods for supporting pipes and conduits
- Supports multiple runs of pipe and conduit on roofs and below raised floors
- Supports concentrated loads up to 600 lbs
- Absorbs shock and vibration
- Protects roof membrane
- Metal cover protects from weather and other environmental conditions
- Features an electro-galvanized finish for corrosion protection



Part Number	Max. Working Load (lbs)	Height (in)	Thread Size	Surface Finish	With Strut
RPS300T1	300	3 3/16	3/8-16	EG	No
RPS300T2	300	4	3/8-16	EG	Yes

# Cable/Conduit

## CADDY® PYRAMID 600

### Pipe & Equipment Supports

#### Features

- Consists of two CADDY® PYRAMID 300 bases tied together with a length of strut
- Footprint is 32" x 12" (24" x 16" optional with cutting of strut) for more even load distribution
- Supports up to 600 lb loads
- Helps to protect the roof membrane



Part Number	Max. Working Load (lbs)	Height (in)	Thread Size	Surface Finish	With Strut
RPS600T2	600	4	3/8-16	EG	Yes





# Cable/Conduit

## Metal Deck Conduit Support

### Features

- Provides spacing between conduit and deck surface
- Easily attached with screw gun or power tool
- Permits conduit to be laid out and then attached
- Eliminates offset bending conduit



Part Number	Description	Standard Packaging Quantity
AOL8P	Support bracket for 1/2" EMT	100
AOL12P	Support bracket for 3/4" EMT or 1/2" Rigid	100
AOL16P	Support bracket for 1" EMT or 3/4" Rigid	100

Notes: No Load Rating - Positioning Only

## Nail Bracket

### Features

- Used to attach conduit to wood, steel or concrete
- Eliminates the need for offset bends
- Works with power tools, screw guns or nails
- May be attached after positioning conduit



Part Number	Description	Standard Packaging Quantity
CNB812M	Nail Bracket, M-Series 1/2" & 3/4" Conduit	100
CNB8P	Nail Bracket, P-Series for 1/2" EMT	100
CNB12P	Nail Bracket, P-Series for 3/4" EMT or 1/2" Rigid	100

Notes: No Load Rating - Positioning Only



Visit the ERICO website at [www.erico.com](http://www.erico.com) for new product information, up-to-date product specifications and applications, a list of upcoming events and industry tradeshow participation and more.

A full literature library provides pertinent literature in an easy-to-download PDF format. This is a great way to stay informed on all the current publications. New product brochures and datasheets are posted as soon as they are printed.

In the News & Events section, customers can find new product updates, press releases and lists of seminars.

Locations and contact information is listed for ERICO offices around the world as well as where to buy ERICO products.

[www.erico.com](http://www.erico.com) provides a convenient way to get the answers you need day or night. Visit ERICO online.

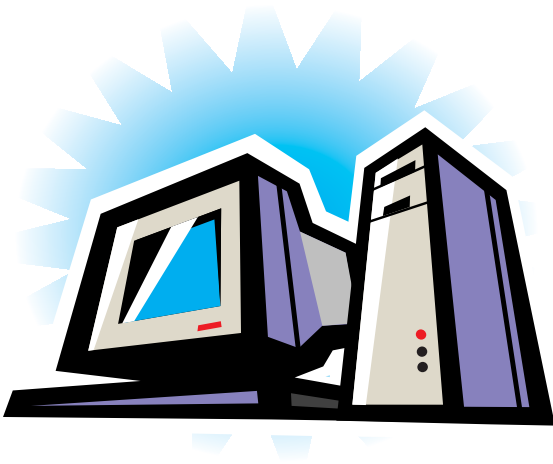

# Beam/Purlin



# Beam/Purlin

## Spring Steel Beam Clamps

### Features

- Eliminates offset bending conduit
- BCISN375 has built-in Smart Nut which snaps directly onto 3/8" -16 threaded rod, is adjustable and removable, and eliminates extensive "threading" into place
- Easy installation to beam flanges up to 1/2"
- Accommodates standard 1/4"-20 or #10-24 threaded bridle rings
- Supports 1/4" and 3/8" threaded rod, S-hooks, electrical boxes, conduit and bridle rings



Fig. #1

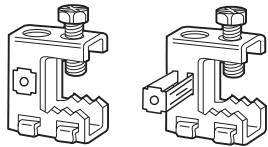

Fig. #2

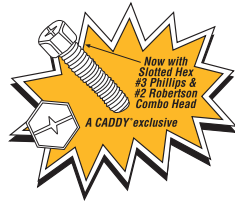

Fig. #3



Fig. #4



Fig. #5



Fig. #6



# Beam/Purlin

Part Number	Fig. #	Description	Static Load (lbs)	Standard Packaging Quantity
BC	1	Beam clamp thru 1/2" flange	100	100
BCISN375	2	Beam clamp thru 1/2" flange with 3/8-16 Smart Nut	100	100
BC812M	3	1/2" or 3/4" conduit to beam thru 1/2" flange	100	100
BC16M	3	1" conduit to beam thru 1/2" flange	100	100
BC20M	3	1 1/4" conduit to beam thru 1/2" flange	100	100
BC24M	3	1 1/2" conduit to beam thru 1/2" flange	100	50
BC32M	3	2" conduit to beam thru 1/2" flange	100	50
BC812MSM	4	1/2" or 3/4" conduit to beam thru 1/2" flange, side mount	25	100
BC16MSM	4	1" conduit to beam thru 1/2" flange, side mount	25	100
BC20MSM	4	1 1/4" conduit to beam thru 1/2" flange, side mount	25	100
BC24MSM	4	1 1/2" conduit to beam thru 1/2" flange, side mount	25	50
BC32MSM	4	2" conduit to beam thru 1/2" flange, side mount	25	50
BC8P	5	1/2" conduit to beam thru 1/2" flange	25*	100
BC12P	5	3/4" conduit to beam thru 1/2" flange	25*	100
BC16P	5	1" conduit to beam thru 1/2" flange	25*	100
BC8PSM	6	1/2" conduit to beam thru 1/2" flange, side mount	15*	100
BC12PSM	6	3/4" conduit to beam thru 1/2" flange, side mount	15*	100
BC16PSM	6	1" conduit to beam thru 1/2" flange, side mount	15*	100

\*Ultimate static load limit.

**Notes:** When using rigid conduit on P-Series, use next size larger clip (1/2" Rigid use 12P)

# Beam/Purlin

## Beam Clamps

### Features

- Easy installation to beam flanges up to 1/2"
- Supports 1/4" threaded rod, 1/4" threaded bridle rings and boxes
- Available riveted to conduit clips 1/2" thru 2"
- Bright zinc finish
- Eliminates offset bending conduit



Fig. #1

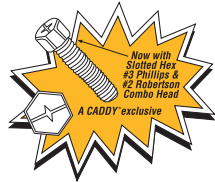

Static Load (lbs): 100

Part Number	Fig. #	Rigid (in)	EMT (in)	Standard Packaging Quantity
BC200	1	-	-	50
BC200CD0B	2	1/2	1/2	50
BC200CD1B	2	3/4	3/4	50
BC200CD2.5B	2	-	1 1/4	50
BC200CD2B	2	1	1	50
BC200CD3B	2	1 1/4	1 1/2	50
BC200CD4B	2	1 1/2	-	25
BC200CD5B	2	2	2	25



Fig. #2

**Notes:** Threaded hole on back and bottom-See Misc. Components section for threaded bridle rings.

## Big Beam Clamp

### Features

- Ideal for Electrical, Mechanical, and HVAC Applications



Static Load (lbs): 200

Part Number	Description	Standard Packaging Quantity
BC400	For 3/8-16 threaded rod or 3/8" - 16 bolts to beam flange through 3/4"	25



# Beam/Purlin

## Hammer-On Flange Clip

### Features

- Provides a “portable” 1/4” hole
- Fits most beams and bulb tees
- Installs with just a hammer



Part Number	Flange Thickness (in)	Standard Packaging Quantity	Static Load (lbs)
2H4	3/32 to 9/64	100	160
4H24	1/8 to 1/4	100	200
4H58	5/16 to 1/2	100	200
4H912	9/16 to 3/4	100	200



See CADDY® SPEED LINK chapter for more information

# Beam/Purlin

## Hammer-On Plain and Threaded Rod Hangers

### Beam Clamps

#### Features

- Requires only a hammer to install
- Used to suspend #8 wire, 1/4", 3/8" plain rod or 1/4" or 3/8" threaded rod from beam flanges 1/8" to 3/4" thick



Fig. #1

Static Load: 200 lbs

Part Number	Fig. #	Flange Thickness (in)	Rod Size	Standard Packaging Quantity
70824	1	1/8 to 1/4	#8 wire or 1/4" Plain Rod	100
70858	1	5/16 to 1/2	#8 wire or 1/4" Plain Rod	100
708912	1	9/16 to 3/4	#8 wire or 1/4" Plain Rod	100
6A24	2	1/8 to 1/4	3/8" (Plain)	100
6A58	2	5/16 to 1/2	3/8" (Plain)	100
6A912	2	9/16 to 3/4	3/8" (Plain)	100
4TI24	3	1/8 to 1/4	1/4-20	100
4TI58	3	5/16 to 1/2	1/4-20	100
4TI912	3	9/16 to 3/4	1/4-20	100
6TI24	3	1/8 to 1/4	3/8-16	100
6TI58	3	5/16 to 1/2	3/8-16	100
6TI912	3	9/16 to 3/4	3/8-16	100
6TA24	3	1/8 to 1/4	1/4-20 or 3/8-16 Threaded*	100
6TA58	3	5/16 to 1/2	1/4-20 or 3/8-16 Threaded*	100
6TA912	3	9/16 to 3/4	1/4-20 or 3/8-16 Threaded*	100

\*Nuts required.



Fig. #2



Fig. #3





# Beam/Purlin

## Hammer-On Flange Clip - Universal

### Features

- When used with a CADDY® brand combination conduit hanger, the conduit run lines up with “knock-outs” in outlet box and eliminates offsets and bends.
- Provided with a 1/4-20 thread impression so that the box may be quickly and securely attached to the clamp.
- Also available with a staked stud, 1/4-20 x 3/8” to provide easier attachment of outlet boxes to beams.
- The combination washer-wing nut (Part No. 4WN) can be used to attach box (Not included)
- Allows for use with cable ties
- 1/4-20 x 3/8” screws P/N S3575BP50 available as separate item

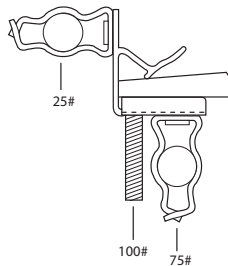

Fig. #1

Part Number	Fig. #	Flange Thickness (in)	Standard Packaging Quantity
M24	1	1/8 to 1/4	100
M58	1	5/16 to 1/2	100
M912	1	9/16 to 3/4	100
M24S	2	1/8 to 1/4	100
M58S	2	5/16 to 1/2	100
M912S	2	9/16 to 3/4	100



Fig. #2



Indicated loads are static load limits and should not be combined.

# Beam/Purlin

## "C" Purlin Clips - Vertical

### Features

- One fastener fits flanges 1/16" to 1/4"
- Supports wire or rod from bar joist and C-Purlin
- Installs from floor with VAFT tool and conduit



Fig. #1

Static Load (lbs): 160

Part Number	Fig. #	Description	Standard Packaging Quantity
VF14	1	Universal attachment to 1/16" to 1/4" angle flange	100
VF14708	2	#8 wire or 1/4" plain rod to 1/16" to 1/4" thick vertical flange	100
VF146A	2	3/8" plain rod to 1/16" to 1/4" thick vertical flange	100
VF144TI	3	1/4-20 threaded rod to 1/16" to 1/4" thick vertical flange	100
VF146TI	3	3/8-16 threaded rod to 1/16" to 1/4" thick vertical flange	100
VF146T	3	1/4-20 or 3/8-16 threaded rod to 1/16" to 1/4" thick vertical flange (nuts required)	100

Notes: Installation tool VAFT.



Fig. #2



Fig. #3



## Installation tool for VF & AF assemblies



Part Number	Description	Standard Packaging Quantity
VAFT	Installation tool for VF & AF assemblies (1/2" conduit not included)	1



# Beam/Purlin

## "Z" Purlin Clips - Angular

### Features

- One fastener fits flanges 1/16" to 1/4"
- Supports wire or rod from bar joist and Z-Purlin
- Installs from floor with VAFT tool and conduit



Fig. #1

Static Load (lbs): 100

Part Number	Fig. #	Description	Standard Packaging Quantity
AF14	1	Universal attachment to 1/16" to 1/4" vertical flange	100
AF14708	2	#8 wire or 1/4" plain rod to 1/16" to 1/4" thick angle flange	100
AF146A	2	3/8" plain rod to 1/16" to 1/4" thick angle flange	100
AF144TI	3	1/4-20 threaded rod to 1/16" to 1/4" thick angle flange	100
AF146TI	4	3/8-16 threaded rod to 1/16" to 1/4" thick angle flange	100
AF146T	3	1/4-20 or 3/8-16 threaded rod to 1/16" to 1/4" thick angle flange (nuts required)	100

Notes: Installation tool VAFT.



Fig. #2



Fig. #3



Fig. #4



# Beam/Purlin

## Multi-Flange Rod Hanger

### Features

- C or Z Purlins or up to 1/4" (7mm) horizontal beam flanges
- Slotted, Hex, Robertson, Phillips combo head bolt
- Hardened cup point setscrew for secure grip
- Fast installation of threaded components
- Integrated thread eliminates need for nuts
- Structural attachment to bottom of purlins and beams to support threaded rod.
- Swivel feature option
- Electrogalvanized finish for corrosion protection



Fig. #1



Part Number	Fig. #	Description	Thread Size (in)	Standard Packaging Quantity
PH4	1	Multi-Flange Beam Clamp for 1/4" Rod	1/4-20	25
PH6	1	Multi-Flange Beam Clamp for 3/8" Rod	3/8-16	25
PHSW4	2	Multi-Flange Beam Clamp with Swivel for 1/4-20 Rod	1/4-20	25
PHSW6	2	Multi-Flange Beam Clamp with Swivel for 3/8-16 Rod	3/8-16	25

**Notes:** Recognizing that torque wrenches are generally not used or available on many job sites, the setscrew should be tightened so it contacts the beam and then an additional 1/4 to 1/2 turn added. Loads up to 200 lbs. (0.90 kN) on C or Z purlins or 160 lbs. (0.71 kN) on horizontal beams.



Fig. #2



# Beam/Purlin

## Z Purlin Clips

### Features

- Hammer-on clip compensates for angle of purlin
- Provides method for attaching conduit and boxes to purlin



Fig. #1

Part Number	Fig. #	Description	Standard Packaging Quantity
122	1	1/4" hole to Z purlin	100
123	2	1/4" bottom hole to Z purlin	100
122708	3	For #8 wire or 1/4" plain rod to Z purlin	100
1226A	3	For 3/8" plain rod to Z purlin	100
1224TI	4	For 1/4" threaded rod to Z purlin	100
1226TI	4	For 3/8" threaded rod to Z purlin	100
1226T	4	For 1/4" and 3/8" threaded rod to Z purlin, nuts required	100
1236M	5	For 3/8" conduit to Z purlin	100
123812M	5	For 1/2" to 3/4" conduit to Z purlin	100
1238P*	6	For 1/2" conduit to Z purlin	100
12312P*	6	For 3/4" conduit to Z purlin	100
12316M	5	For 1" conduit to Z purlin	100
12316P*	6	For 1" conduit to Z purlin	50
12320M	5	For 1 1/4" conduit to Z purlin	50

\*When using rigid conduit on P series, use next size larger clip (1/2" Rigid use 12P).

**Notes:** Loads indicated are for CADDY® Fasteners only

Purlin thickness 13 to 16 gage

Static load limit 100 lbs. except for P Series which is 25 lbs. ultimate static load limit



Fig. #2



Fig. #3



Fig. #4



Fig. #5



Fig. #6



# Beam/Purlin

## Retainer Strap Assemblies

### Features

- Only one piece to install
- Fast hammer on installation
- Riveted retainer strap replaces cumbersome assemblies and hardware
- Retainer strap is easily bent into position
- Lightweight design, heavyweight results



Fig. #1

Part Number	Fig. #	Description	Load Limit (lbs)
CM245	1	1/8" - 1/4" Flange - 1/4-20 x 3/8" Stud	75
CM585	1	5/16" - 1/2" Flange - 1/4-20 x 3/8" Stud	75
CM9125	1	9/16" - 3/4" Flange - 1/4-20 x 3/8" Stud	75
C4T124	2	1/8" - 1/4" Flange - 1/4-20 Threaded Rod	200
C4T158	2	5/16" - 1/2" Flange - 1/4-20 Threaded Rod	200
C4T1912	2	9/16" - 3/4" Flange - 1/4-20 Threaded Rod	200
C6T124	2	1/8" - 1/4" Flange - 3/8-16 Threaded Rod	200
C6T158	2	5/16" - 1/2" Flange - 3/8-16 Threaded Rod	200
C6T1912	2	9/16" - 3/4" Flange - 3/8-16 Threaded Rod	200
CM24812M	3	1/8" - 1/4" Flange - 1/2" & 3/4" Conduit	75
CM2416M	3	1/8" - 1/4" Flange - 1" Conduit	75
CM58812M	3	5/16" - 1/4" - 1/2" & 3/4" Conduit	75
CM5816M	3	5/16" - 1/4" - 1" Conduit	75
CM912812M	3	9/16" - 3/4" - 1/2 & 3/4 Conduit	75
CM91216M	3	9/16" - 3/4" - 1 Conduit	75
C24812SM	4	1/8" - 1/4" Flange - 1/2" - 3/4" Conduit	25
C2416SM	4	1/8" - 1/4" Flange - 1" Conduit	25
C58812SM	4	5/16" - 1/4" Flange - 1/2" - 3/4" Conduit	25
C5816SM	4	5/16" - 1/2" Flange - 1 Conduit	25
C912812SM	4	9/16" - 3/4" Flange - 1/2" - 3/4" Conduit	25
C91216SM	4	9/16" - 3/4" Flange - 1 Conduit	25

Standard Packaging Quantity: 50



Fig. #2



Fig. #3



Fig. #4



## Bulb Tee Clip

### Features

- Provides means of support from underside of bulb tee 1-1/2" thru 2-3/8" wide
- Ceiling material not defaced when correctly applied
- Requires only a hammer to install
- Eliminates offset bending conduit



Fig. #1

Part Number	Fig. #	Description	Standard Packaging Quantity
4J2438	1	Jr. Beam Clamp for bulb tees - Use standard 1/4" carriage bolt (not furnished)	100
4NJ2438*	2	Jr. Beam Clamp for bulb tee with 3/8" long 1/4-20, nut included	100
6NJ2438*	2	Jr. Beam Clamp for bulb tees - 3/8-16 nut included	100
4J2438S	2	Jr. Beam Clamp for bulb tees - 1/4-20, stud included	100

\*nut included

**Notes:** Other stud lengths quoted on request; Will support 135 lbs. static load limit from a 1-1/2" wide flange



Fig. #2



# Beam/Purlin

## Wide Mouth Beam Clamps Models BC13/BC14



Fig. #1

### Features

- BC13 Heavy duty steel beam clamp to fit up to 7/8" (22mm) thick flanges
- BC14 Heavy duty steel beam clamp to fit flanges from 5/8" (16 mm) to 15/8" (41 mm) thick
- Hardened cup point setscrew to provide secure grip on tapered sections
- Electrogalvanized finish for corrosion protection
- Retaining strap available separately, for more secure attachment for industrial applications (see BC09 Series)
- Threaded to allow quick and easy attachment of threaded rod or bolted components

Part Number	Fig. #	Rod Size	Bolt Size	Flange Thickness (Max) (in)	Standard Packaging Quantity	Load Capacity (lbs)
BC130025EG	1	1/4-20	3/8-16	7/8	20	650
BC130037EG	1	3/8-16	3/8-16	7/8	20	650
BC130050EG	1	1/2-13	1/2-13	7/8	10	1,100
BC130062EG	1	5/8-11	1/2-13	7/8	10	1,600
BC140037EG	2	3/8-16	3/8-16	1 5/8	20	800
BC140050EG	2	1/2-13	1/2-13	1 5/8	20	1,300
BC140062EG	2	5/8-11	1/2-13	1 5/8	10	1,900

Minimum flange thickness 5/8" (16 mm).

**Notes:** Recognizing that torque wrenches are generally not used or available on many job sites, the setscrew should be tightened so it contacts the beam and then an additional 1/4 to 1/2 turn added. Setscrew must be tightened and torqued onto the sloped side of the I-beam.

Retaining strap available separately, for more secure attachment



Fig. #2





# Beam/Purlin

## Malleable Beam Clamp Model 255



### Features

- For attachment to beams or angles up to 3/4" (20 mm) thick
- Hardened cup point setscrew to provide secure grip on tapered sections
- Malleable iron clamp with electrogalvanized finish for enhanced corrosion protection
- Available for 3/8" to 5/8" threaded rod size
- Retaining strap available separately, for more secure attachment (for Model 255C)

Part Number	Bolt Size	Flange Thickness (in)	Fastener Height (in)	Width (in)	Standard Packaging Quantity	Rec# Load (lbs)
2550037EG	3/8-16	3/4	1 3/4	1 11/16	100	400
2550050EG	3/8-16	3/4	1 3/4	1 11/16	100	400
2550062EG	3/8-16	3/4	2 15/16	2 1/2	50	400



# Beam/Purlin

## Reversible Beam Clamps Model 300 & 310

### Features

- Conforms with Federal Specification WW-H-171 (Type 23), Manufacturers Standardization Society ANSI/MSS-SP-58 (Type 19 & 23), install in accordance with ANSI/MSS-P-69
- Malleable iron clamp with electrogalvanized finish for enhanced corrosion protection
- Available in hot dipped galvanized finish (special order)
- Hardened cup point setscrew to provide secure grip on tapered sections
- Accommodates attachment of 1/4" dia. threaded rod, bridle rings and boxes from three positions – top, bottom and back
- Retaining strap available separately (for Model 300C)
- Reversible for attachment to top or bottom flange



Fig. #1

Part Number	Fig. #	Rod Size	Flange Thickness (in)	Fastener Height (in)	Fastener Width (in)	Standard Packaging Quantity	Bottom Mount Load (lbs)	Top Mount Load (lbs)
3000037EG	1	3/8-16	3/4	1 9/16	13/16	100	250	500
3000050EG	1	1/2-13	3/4	1 13/16	1 1/16	50	760	950
3000062EG	1	5/8"	3/4	1 13/16	1 1/16	50	760	950
3000075EG	1	3/4"	3/4	1 3/4	1 1/8	50	760	950
3100037EG	2	3/8"	1 1/4	2 1/16	13/16	50	250	500
3100050EG	2	1/2"	1 1/4	2 3/8	1 1/16	50	760	950
BC260025EG	3	1/4-20	1/4	-	-	100	100	250

**Notes:** Safety factor of 3.5. Available in hot dipped galvanized finish (special order)

Finish: Electro-zinc plated (EG)



Fig. #2



Fig. #3



# Beam/Purlin

## Multi-Purpose Purlin Clamp Models 315



### Features

- Large mouth opening (15/8" - 41 mm) to fit large thick flange (bottom flange) steel beams or angles and large lip "C" or "Z" Purlins
- Available for threaded rod sizes 3/8" diameter
- Locknut and hardened cup point setscrew to provide secure grip on tapered sections
- Malleable iron clamp with electrogalvanized finish for enhanced corrosion protection
- Available in hot dipped galvanized finish (special order)
- Attaches to a wide variety of structural sections including "C" or "Z" Purlins, angles, channels and beams

Part Number	Rod Size	Bolt Size	Flange Thickness (in)	Surface Finish	Standard Packaging Quantity	Rec# Load (lbs)
3150037EG	3/8-16	3/8-16	1	EG	25	400



# Beam/Purlin

## Beam Clamp with Swivel Option Model BC10



Fig. #1

### Features

- For attachment to beams or angles up to 3/4" (20 mm) thick
- Hardened cup point setscrew to provide secure grip on tapered sections
- Stamped steel with electrogalvanized finish for enhanced corrosion protection
- Available in hot dipped galvanized finish (special order)
- J-Bolt assembly available for more secure attachment in industrial applications
- Designed to allow swivel up to 15° from bottom holes or with the use of BC15 swivel (available separately) for attachment to inclined beams without bending the rod
- Accommodates rod sizes up to 1/2" dia. (max)

Part Number	Fig. #	Rod Size (in)	Flange Thickness (in)	Surface Finish	Standard Packaging Quantity	Max. Rec. Load (lbs)
BC100000EG	1	1/2	3/4	EG	25	300; 500
BC101500EG	2	1/2	3/4	EG	25	500

**Note:** F1 is the load rating from the front hole (500 lbs); F2 is the load rating from the back hole (300 lbs)



Fig. #2

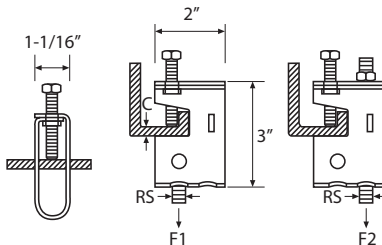

# Beam/Purlin

## Beam Retainer Accessories

J-Bolt for use with BC10 Beam Clamp

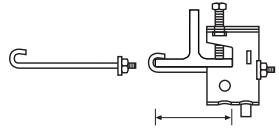

Fig. #1

Part Number	Fig. #	Description
BC110000EG	1	Beam Clamp with 8" J-Bolt
BC120000EG	1	Beam Clamp with 12" J-Bolt



Retainer Straps for use with BC13 and BC14 Beam Clamps



Fig. #2

Part Number	Fig. #	Description	Standard Packaging Quantity	Flange Width (in) [Max]
BC090900EG	2	Anchor Strap 9"	50	6
BC091200EG	2	Anchor Strap 12"	50	9
BC091500EG	2	Anchor Strap 15"	25	12

# Beam/Purlin

## Rod Hanger Beam Clamp Model 200

### Features

- For attachment to beams or angles up to 3/4" (20 mm) thick
- Locknut and hardened cup point setscrew to provide secure grip on tapered sections
- Stamped steel with electrogalvanized finish for enhanced corrosion protection
- Available for 3/8" to 5/8" threaded rod size
- Available in hot dipped galvanized finish
- Retaining strap available separately, for more secure attachment for industrial applications (for Model 345L, 300C, and 35RS)



Part Number	Rod Size	Bolt Size	Flange Thickness (in)	Height (in)	Width (in)	Standard Packaging Quantity	Rec# Load (lbs)
2000037EG	3/8-16	3/8-16	3/4	2 3/8	2 1/4	100	250

Notes: Safety factor of 5.



# Beam/Purlin

## Pipe-To-Beam Clamps

### Features

- Ideal for direct attachment of RMC or service pipe sections
- Malleable iron casting with steel hardware
- Hot dipped galvanized coating for superior corrosion protection
- Range for 3/8" to 4" diameter pipe
- Available with stainless steel hardware (special order)



RA

Part Number	Pipe Size (in)	Rec# Load (lbs)	Standard Packaging Quantity	Qty. Exception
PAR- — RA- 0037HD	3/8	200	25	-
PAR- ET- RA- 0050HD	1/2	250	25	-
PAR- ET- RA- 0075HD	3/4	300	25	-
PAR- ET- RA- 0100HD	1	400	25	-
PAR- ET- RA- 0125HD	1 1/4	400	25	-
PAR- ET- RA- 0150HD	1 1/2	500	20	PAR-25
PAR- ET- RA- 0200HD	2	600	20	-
PAR- ET- RA- 0250HD	2 1/2	700	10	PAR- 10; ET-25; RA-20
PAR- ET- RA- 0300HD	3	800	10	RA-15
PAR- — RA- 0350HD	3 1/2	900	10	-
PAR- — RA- 0400HD	4	1,000	10	-

**Notes:** C Max is 1/4"/20 mm.); Available with stainless steel hardware (special order.)



PAR



ET



# Code-Compliant Product Design

ERICO® is committed to ongoing product development. To maintain product quality and customer satisfaction, we incorporate the latest codes, standards and requirements into the development and engineering of our product offerings. Our continued focus on code compliance helps ensure we meet the needs and installation efficiencies of our customers. This also provides assurance that CADDY® brand products from ERICO conform to local and national codes, regulations and standards. As always, ERICO's customers can trust that CADDY products exemplify quality and performance.

For specific code requirements, please refer to the code body websites or published guides.





# Strut



## CADDY® ERISTRUT CHANNEL



Part Number	Description	Qty. Per
A121000PG	12GA Solid 1 5/8" 10' Pre-Galv	500' bundle
A122000GN	12GA Solid 1 5/8" 20' Green	500' bundle
A122000PG	12GA Solid 1 5/8" 20' Pre-Galvanized	500' bundle
A122000PL	12GA Solid 1 5/8" 20' Plain	500' bundle
A12A1000GN	12GA Welded 1 5/8" 10' Green	250' bundle
A12A1000PG	12GA Welded 1 5/8" 10' Pre-Galvanized	250' bundle
A12A2000GN	12GA Welded 1 5/8" 20' Green	200' bundle
A12A2000PG	12GA Welded 1 5/8" 20' Pre-Galvanized	200' bundle
A12AH100PG	12GA Half Slot Welded 1 5/8" 10' Pre-Galvanized	250' bundle
A12AH200GN	12GA Half Slot Welded 1 5/8" 20' Green	200' bundle
A12AH200PG	12GA Half Slot Welded 1 5/8" 20' Pre-Galvanized	200' bundle
A12H1000CG	12GA Half Slot 1 5/8" 10' Chromate (Gold)	500' bundle
A12H1000GN	12GA Half Slot 1 5/8" 10' Green	500' bundle
A12H1000PG	12GA Half Slot 1 5/8" 10' Pre-Galvanized	500' bundle
A12H2000CG	12GA Half Slot 1 5/8" 20' Chromate (Gold)	500' bundle
A12H2000GN	12GA Half Slot 1 5/8" 20' Green	500' bundle
A12H2000PG	12GA Half Slot 1 5/8" 20' Pre-Galvanized	500' bundle
A14H1000CG	14GA Half Slot 1 5/8" 10' Chromate (Gold)	500' bundle
A14H1000GN	14GA Half Slot 1 5/8" 10' Green	500' bundle
A14H1000PG	14GA Half Slot 1 5/8" 10' Pre-Galvanized	500' bundle
A14H2000GN	14GA Half Slot 1 5/8" 20' Green	500' bundle
A14H2000PG	14GA Half Slot 1 5/8" 20' Pre-Galvanized	500' bundle
C12H1000CG	12GA Half Slot 13/16" 10' Chromate (Gold)	500' bundle
C12H1000GN	12GA Half Slot 13/16" 10' Green	500' bundle
C12H1000PG	12GA Half Slot 13/16" 10' Pre-Galvanized	500' bundle
C12H2000GN	12GA Half Slot 13/16" 20' Green	500' bundle
C12H2000PG	12GA Half Slot 13/16" 20' Pre-Galvanized	500' bundle
C14H1000CG	14GA Half Slot 13/16" 10' Chromate (Gold)	500' bundle
C14H1000GN	14GA Half Slot 13/16" 10' Green	500' bundle
C14H1000PG	14GA Half Slot 13/16" 10' Pre-Galvanized	500' bundle
C14H2000CG	14GA Half Slot 13/16" 20' Chromate (Gold)	500' bundle
C14H2000GN	14GA Half Slot 13/16" 20' Green	500' bundle
C14H2000PG	14GA Half Slot 13/16" 20' Pre-Galvanized	500' bundle
CONC122000PG	13/16 Continuous Concrete Insert Pre-Galvanized	500' bundle



# Strut

Model	Width (in)	Height (in)	Gauge
A12	1-5/8	1-5/8	12
A14	1-5/8	1-5/8	14
C12	1-5/8	13/16	12
C14	1-5/8	13/16	14

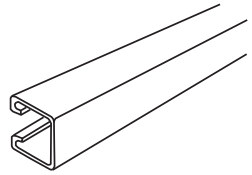

Solid (S)

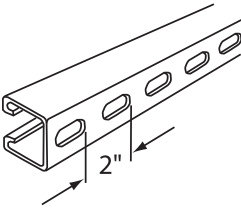

Half Slot (H)  
1-1/8" x 9/16" slots  
punched on 2" centers

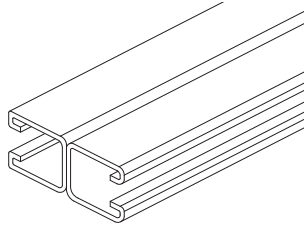

Welded  
Two or more length tack  
welded together ("A"  
configuration shown)



CON  
Continuous Concrete Insert

# Strut

## Strut Nuts



Fig. #1



Fig. #2



Fig. #3



Fig. #4



Fig. #5



Fig. #6



Fig. #7



Fig. #8



# Strut

1 5/8" (41 mm) wide

Part Number	Fig. #	Description
MFA4I	1	1/4-20 thread impression
NUT0025EG	2	Strut Nut w/o Spring 1/4"
NUT0031EG	2	Strut Nut w/o Spring 5/16"
NUT0037EG	2	Strut Nut w/o Spring 3/8"
NUT0050EG	2	Strut Nut w/o Spring 1/2"
NUT0062EG	2	Strut Nut w/o Spring 5/8"
NUT0075EG	2	Strut Nut w/o Spring 3/4"
TSNT0025EG	3	Top Spring Nut for 1/4" Channel
TSNT0037EG	3	Top Spring Nut for 3/8" Channel
TSNT0050EG	3	Top Spring Nut for 1/2" Channel

1 5/8" x 1 5/8" (41 mm x 41 mm) or

1 5/8" x 1 3/8" (41 mm x 35 mm)

Part Number	Fig. #	Description
SPRA0037EG	4	Spring Nut for A&B Channel 3/8"
SPRA0050EG	4	Spring Nut for A&B Channel 1/2"

1 5/8" x 13/16" (41 mm x 21 mm)

Part Number	Fig. #	Description
SPRC0025EG	5	Spring Nut for C Channel 1/4"
SPRC0050EG	5	Spring Nut for C Channel 1/2"

1 5/8" x 2 7/16" (41 mm x 62 mm) or

1 5/8" x 3 1/4" (41 mm x 83 mm)

Part Number	Fig. #	Description
SPRD0025EG	6	Spring Nut for D&E Channel 1/4"
SPRD0037EG	6	Spring Nut for D&E Channel 3/8"
SPRD0050EG	6	Spring Nut for D&E Channel 1/2"
SPRD0062EG	6	Spring Nut for D&E Channel 5/8"
SPRD0075EG	6	Spring Nut for D&E Channel 3/4"

Part Number	Fig. #	Description	Stud Length (in)
MFA625	7	1/4-20 x 5/8" stud	5/8
SPRM2508EG	8	Stud Spring Nut 1/4" x 7/8"	7/8
SPRM2511EG	8	Stud Spring Nut 1/4" x 1-1/8"	1 1/8
SPRM3711EG	8	Stud Spring Nut 3/8" x 1-1/8"	1 1/8
SPRM5011EG	8	Stud Spring Nut 1/2" x 1-1/8"	1 1/8
SPRM5013EG	8	Stud Spring Nut 1/2" x 1-3/8"	1 3/8

# Strut

## CADDY® SLICK NUT

### Features

- Eliminates the need for hard-to-handle spring nuts and a washer
- Unique one-piece design installs with one hand
- Provides fast, universal attachment of threaded rod and hardware to standard strut profiles
- Reduces installation time by up to 50%
- Easily fits all standard strut depths – reducing inventory
- For use in indoor environments



Part Number	Thread Size	Recommended Torque (ft lb)	F1 Load (lbs.)		F2 Load (lbs.)		Standard Packaging Quantity
			12 GA	14 GA	12 GA	14 GA	
SLICK250	1/4-20	5	250	150	800	800	100
SLICK375	3/8-16	15	400	300	1,100	1,100	100
SLICK500	1/2-13	20	650	550	1,250	1,100	100

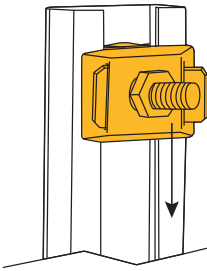

F1 Load

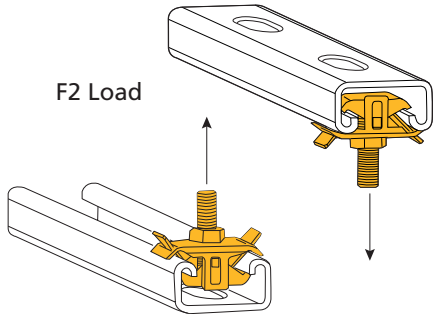

# Strut

## STS (Strut-to-Strut) Strut Clamp

### Features

- Provides fast assembly of back-to-back half-slot strut as an alternative to welded strut
- Unique one-piece assembly that eliminates the need for bolts, washers, and nuts
- For new or retrofit applications
- Allows joining of dissimilar half-slot channel, regardless of profile size or finish
- Easy installation with a 1/2" nut driver
- Can be used on CADDY® ERISTRUT or any half-slot strut with minimal half slot dimensions of 9/16" x 7/8"



Part Number	Description	Load (lbs)	Recommended Torque (ft-lbs)	Standard Packaging Quantity
STS	Strut-to-Strut Clamp	1,000	5	100

**Note:** 1000 lbs working load per total assembly (5:1 safety factor). Not to exceed 1000 lbs. Half-slot dimensions vary by manufacturer. Minimum half-slot dimensions 14 mm x 22 mm. Strut type and structure need to be evaluated to establish load for assembly. Use 1 STS per 1 ft. of strut, minimum of 2 required.

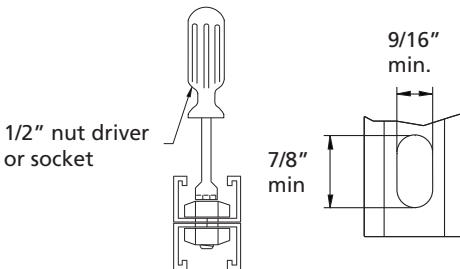

# Strut

## Rigid Pipe Clamp One-Piece



### Features

- Supports rigid pipe to strut
- Handles heavy loads
- One -piece design incorporates a retained bolt and built-in nut
- Installs with either a screwdriver or a nut driver
- Complete line is available to fit a wide range of pipe sizes
- Available in various materials and finishes

Part Number	Pipe Size (in)		Load (lbs)	Standard Packaging Quantity
	Nominal	O.D.		
RIGD0050XX	1/2	0.840	400	100
RIGD0075XX	3/4	1.050	400	100
RIGD0100XX	1	1.315	600	100
RIGD0125XX	2 3/4	1.660	600	50
RIGD0150XX	5 1/2	1.900	800	50
RIGD0200XX	2	2 3/8	800	50
RIGD0250XX	10 1/2	2 7/8	800	25
RIGD0300XX	3	3 1/2	800	25
RIGD0350XX	15 1/2	4	1,000	25
RIGD0400XX	4	4 1/2	1,000	25

**Notes:** XX denotes finish available: EG - Electro-Galvanized, CG - Yellow Chromate, S4 - Stainless 304, S6 - Stainless 316, HD - Hot Dipped Galvanized, AL - Aluminum.





# Strut

## One-Piece Strut Clamp

### SCH Series

#### Features

- One-piece installation – no screws or bolts to drop
- Installs quickly and easily; requires only a screwdriver or nut driver for installation
- Heavy-duty construction with a bright zinc finish
- Size 3/8" MC/AC to 4" EMT conduit
- All sizes available with load distribution plate attached to screw
- Surface finish: electro zinc plated



Fig. #2



Part Number	Fig. #	EMT (in)	Rigid (in)	Cable OD (in)	Static Load (lbs)	Standard Packaging Quantity
SCH8	1	1/2	-	-	200	100
SCH12	1	3/4	1/2	-	200	100
SCH16	1	1	3/4	-	200	100
SCH20	1	1 1/4	1	-	200	100
SCH6B	2	3/8	-	0.100 - 0.630	200	100
SCH8B	2	1/2	-	0.340 - 0.710	200	100
SCH12B	2	3/4	1/2	0.570 - 0.920	200	100
SCH16B	2	1	3/4	0.720 - 1.160	200	100
SCH20B	2	1 1/4	1	1.000 - 1.510	200	100
SCH24B	2	1 1/2	1 1/4	1.250 - 1.750	350	50
SCH32B	2	2	1 1/2	1.740 - 2.200	350	50
SCH40B	3	-	2	2.000 - 2.380	350	25
SCH48B	3	2 1/2	2 1/2	2.380 - 2.880	350	25
SCH56B	3	3	3	2.720 - 3.500	350	25
SCH64B	3	3 1/2	3 1/2	3.250 - 4.000	350	10
SCH72B	3	4	4	3.850 - 4.500	350	10



Fig. #1



Fig. #3



# Strut

## Universal One-Piece Strut Clamp

### SK Series

#### Features

- One-piece construction
- Retained bolt and built-in nut prevents dropping of loose parts
- One size fits EMT and Rigid
- Installs with screwdriver, standard wrench or nut driver
- Break in half and install
- Bright zinc finish
- Works with standard 1 5/8" Strut



Fig. #1



Fig. #2

Part Number	Fig. #	EMT Rigid (in)	Standard Packaging Quantity
<b>Mild Steel - Static Load 200 lbs.</b>			
SK125I	1	3/4	100
SK165I	1	1	100
SK205I	1	1 1/4	100
SK245I	1	1 1/2	50
SK325I	1	2	50
SK85I	1	1/2	100
<b>Mild Steel - Static Load 350 lbs.</b>			
SK405I	2	2 1/2	50
SK485I	2	3	50
SK565I	2	3 1/2	25
SK645I	2	4	25



# Strut

## Dual Purpose Strut/ Beam Clamps

### Features

- More versatile alternative to window bracket or standard beam clamp
- Supports strut and/or rod
- Lock nut and hardened cup point setscrew provide secure grip on tapered sections
- Permits strut channel opening positioning in any direction



Fig. #1

Part Number	Fig. #	Description	Rod Size	Max. Flange Thickness (in)	Load (lbs)	Standard Packaging Quantity
200RS375	1	Dual Purpose Strut/Beam Clamp 3/8-16	3/8-16	1	250	10
200RS500	2	Dual Purpose Strut/Beam Clamp 1/2-13	1/2-13	1	360	10
STCB6*	3	Dual Purpose Strut/Beam Clamp, Widemouth 3/8-16	3/8-16	2	400	10

\*When used as a Strut Beam Clamp, Min-Max flange size is 3/4" - 1 5/8". When used as a beam clamp without strut, Min-Max flange size is 1 1/2" - 2".

**Notes:** Load rating based on single clamp. When used as strut hanger minimum required is two clamps.



Fig. #2



Fig. #3



# Strut

## Beam Clamps for Strut

### Features

- Structural attachment to beams and columns to support strut
- Fits A and D channels



Fig. #1

Part Number	Fig. #	Description	Bolt Size	Max. Flange Size	Load (lbs)	Standard Packaging Quantity
BC16A000EG	1	Channel to Beam Clamp for A Channel	-	7/8" (22 mm)	740	20
BC17A000EG	2	Channel to Beam Clamp for A Channel	-	3/4" (20 mm)	1,200	25
BC17D000EG	2	Channel to Beam Clamp for D Channel	-	3/4" (20 mm)	1,200	25
BC17PL00EG	2	Plate Only	-	-	-	-
BC180037EG	3	Beam Clamp for Strut	3/8-16	1" (25 mm)	660	25
BC180050EG	3	Beam Clamp for Strut	1/2-13	1" (25 mm)	660	25
BC200000EG	4	1/2" Retainer Strap	-	1/2" (13 mm)	460	50
BC210000EG	5	1" Retainer Strap	-	1" (25 mm)	460	25

**Note:** Used in pairs



Fig. #2



Fig. #3



Fig. #4



Fig. #5



# Strut



Fig. #1



Fig. #2



Fig. #3



Fig. #4



Fig. #5

# Strut

## Column Strut Clamps

### Features

- Easy to install, as both parts clip to strut during installation
- For attachment of strut inside wide flange column or beams
- Quick to install - Tightening of only one or two bolts is required
- Fits all 1 5/8" x 1 5/8" strut



Fig. #1



Fig. #2

Part Number	Fig. #	Description	Load (lbs)	Standard Packaging Quantity
BC23A000EG	1	Column Strut Clamp	800	25
INC8T5	2	Column Strut Clamp with mounting plates and two 5/16" x 1" bolts	100	100

**Notes:** Packed in pairs.

Load rating is based upon use in pairs.



# Strut

## Hardware Washer

Part Number	Description	Standard Packaging Quantity
F140000EG	Square Channel Washer 3/8" EG	100
F150000EG	Square Channel Washer 5/8" EG	100

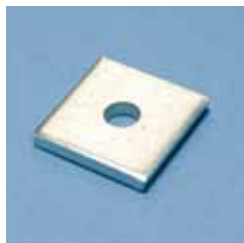

## Threaded Rod

Part Number	Description	Standard Packaging Quantity
0502510EG	Threaded Rod 1/4" x 10' EG	25
0503710EG	Threaded Rod 3/8" x 10' EG	25
0505010EG	Threaded Rod 1/2" x 10' EG	25



# Strut

## ESC

### Features

- Works on industry standard strut profile
- Spring steel permits snap-in attachment without tools
- Provides fast attachment of a 1/4" mounting hole, J-hook, cable, conduit, or 1/4" threaded rod to strut



Fig. #1

Part Number	Fig. #	Description	Standard Packaging Quantity
ESC4	1	Easy Strut Clip	100
ESC6M	2	Snap-in MC/AC cable	100
ESC812M	2	Snap-in 1/2"-3/4" conduit	100
ESC8P	3	Snap-in 1/2" conduit	100
ESC12P	3	Snap-in 3/4" conduit	100
ESC4TI	4	Snap-in 1/4- 20 threaded rod	100
ESC6TI	4	Snap-in 3/8-16 threaded rod	100



Fig. #2



Fig. #3



Fig. #4





# Hangers/Hanging Systems



# Hangers / Hanging Systems

## Rod And Wire Hangers

### Features

- **OFFSET BRACKET** suspends plain rod, threaded rod or wire drops from vertical structures such as laminated wood or concrete beams, joists, ceilings and walls
- **ANGLE BRACKET** suspends plain rod, threaded rod and wire drops from horizontal structures such as laminated wood or concrete beams, joists, ceilings and walls



Fig. #1

Static Load: 160 lbs.

Part Number	Fig. #	Description	Standard Packaging Quantity
<b>Angle Bracket</b>			
4TIB	1	For 1/4" threaded rod, with thread impression	100
6AB	2	For 3/8" plain rod	100
6TB	3	For 1/4" or 3/8" threaded nuts required	100
6TIB	3	For 3/8" threaded rod, with thread impression	100
708AB	4	For #8 wire or 1/4" plain rod	100
<b>Offset Bracket</b>			
4TIO	5	For 1/4" threaded rod, with thread impression	100
6AO	6	For 3/8" plain rod	100
6TIO	7	For 3/8" threaded rod, with thread impression	100
6TO	7	For 1/4" or 3/8" threaded nuts required	100
708AO	8	For #8 wire or 1/4" plain rod	100

**Note:** Loads indicated are for CADDY® Fasteners only. Method of attachment to structure must be evaluated separately.



Fig. #2



Fig. #3



Fig. #4

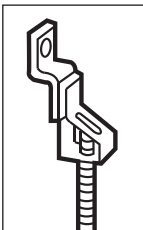

Fig. #5

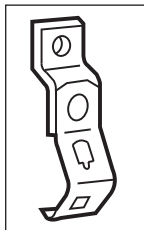

Fig. #6

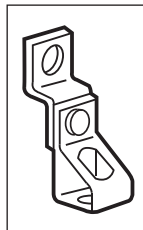

Fig. #7

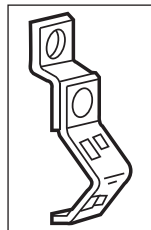

Fig. #8



# Hangers / Hanging Systems

## Pin Driven Angle Brackets

### Features

- Longer leg angle bracket for tool clearance
- Designed to fit a variety of pin drivers
- Improved for easier installation with pin drivers
- Pregalvanized steel
- Preassembly options available for rod, wire, strap and cable applications



Fig. #1

Part Number	Fig. #	Description	Working Load (lbs)	Standard Packaging Quantity
4TIAFAB3	1	For 1/4" threaded rod, with thread impression	160	50
6TAFAB3	1	For 1/4" or 3/8" threaded rod, nuts required	160	100
6TIAFAB3	1	For 3/8" threaded rod, with thread impression	160	100
6AFAB3	2	For 3/8" plain rod	160	100
708AFAB3	3	For #8 wire or 1/4" rod	160	100
AFAB3	4	Angle bracket with 1/4" slotted hole and 3/16" mounting hole	160	100

**Note:** Load limits apply to CADDY® Fasteners only. Pin must be evaluated separately.



Fig. #2



Fig. #3



Fig. #4

# Hangers / Hanging Systems

## Hammer-On Plain and Threaded Rod Hangers

### Beam Clamps

#### Features

- Requires only a hammer to install
- Used to suspend #8 wire, 1/4", 3/8" plain rod or 1/4" or 3/8" threaded rod from beam flanges 1/8" to 3/4" thick



Fig. #1

Static Load: 200 lbs.

Part Number	Fig. #	Flange Thickness (in)	Rod Size	Standard Packaging Quantity
70824	1	1/8 to 1/4	#8 wire or 1/4" Plain Rod	100
70858	1	5/16 to 1/2	#8 wire or 1/4" Plain Rod	100
708912	1	9/16 to 3/4	#8 wire or 1/4" Plain Rod	100
6A24	2	1/8 to 1/4	3/8" (Plain)	100
6A58	2	5/16 to 1/2	3/8" (Plain)	100
6A912	2	9/16 to 3/4	3/8" (Plain)	100
4TI24	3	1/8 to 1/4	1/4-20	100
4TI58	3	5/16 to 1/2	1/4-20	100
4TI912	3	9/16 to 3/4	1/4-20	100
6TI24	3	1/8 to 1/4	3/8-16	100
6TI58	3	5/16 to 1/2	3/8-16	100
6TI912	3	9/16 to 3/4	3/8-16	100
6TA24	3	1/8 to 1/4	1/4-20 or 3/8-16 Threaded*	100
6TA58	3	5/16 to 1/2	1/4-20 or 3/8-16 Threaded*	100
6TA912	3	9/16 to 3/4	1/4-20 or 3/8-16 Threaded*	100

\*Nuts required.



Fig. #2



Fig. #3



# Hangers / Hanging Systems

## Threaded Rod Hanger For Bar Joists

### Features

- Fits open web joists with round bottom chords
- Part No. 4TW for threaded rods or bolts, 1/4-20 thread impression
- Part No. 6W for threaded rods 3/8" and smaller, nuts required
- Permits accurate centering



Fig. #1

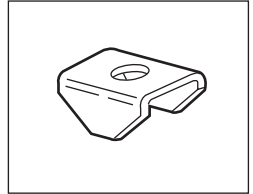
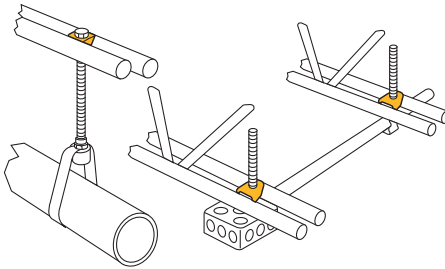

Fig. #2

Part Number	Fig. #	Description	Static Load (lbs)	Standard Packaging Quantity
4TW	1	Threaded wedge hanger	100	100
6W	2	Wedge hanger	200	100



## Fixture Support From Plain Rod

### Features

- No tools required for installation
- Eliminates the use of nut and allows the use of plain rod



Part Number	Size	Static Load (lbs)	Standard Packaging Quantity
2EBN	#8 wire	100	100
4EBN	1/4" plain rod	100	100
6EBN	3/8" plain rod	200	100

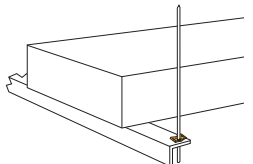

# Hangers / Hanging Systems

## ISN Smart Nut

### Features

- Snaps anywhere on 3/8-16 threaded rod
- Adjustable and removable
- Eliminates excessive threading into place
- Supports plumbing, HVAC, electrical
- Reduces installation time
- Ideal when rod ends are not accessible or for retrofit applications



Part Number	Description	Weight per 100 (lbs)	Max. Recommended Load (lbs)	Standard Packaging Quantity
ISN375	Smart Nut, 3/8-16 thread	3.1	150	100

## ISSP Strut Plate

### Features

- Allows for easy attachment of strut between existing rods.
- Helps eliminate the need for precise cutting of strut and the need for multiple hardware pieces.
- For commercial and industrial applications.
- Bolt has locking design to prevent loosening due to vibration.



Part Number	Description	Max. Rec. Load (lbs)	Weight per 100 (lbs)	Standard Packaging Quantity
ISSP375	Strut Plate Only (No Hardware)	-	36	100
ISSPK	ISN/ISSP Kit (for 3/8-16 threaded rod)	220	10.4	*

\*Order in sets of 12 - 1 set includes (2) ISSP375 and (4) ISN375



# Hangers / Hanging Systems

## Deck Hangers For Rods And Wires

From Cellular Floor Deck  
(H.H. Robertson or R.C. Mahon)



Fig. #1

### Features

- Designed to support #8 wire, 1/4" or 3/8" plain rod, 1/4" or 3/8" threaded rod
- Positive locking through deck tab. Prevents twisting or loosening due to vibration

Part Number	Fig. #	Description	Standard Packaging Quantity
DH2	1	For wrapping wire, "S" hooks, bolting straps	100
DH4TI	2	For 1/4" threaded rod, with thread impression	100
DH6T	2	For 1/4" and 3/8" threaded rod, nuts required	100
DH6TI	2	For 3/8" threaded rod, with thread impression	100
DH6A	3	For 3/8" plain rod	100
DH708	4	For #8 wire or 1/4" plain rod	100

**Note:** Static load limit 160 lbs. Check with deck manufacturer for recommended load capacity.

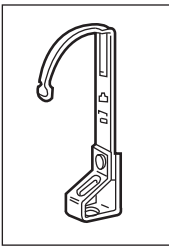

Fig. #2



Fig. #3



Fig. #4

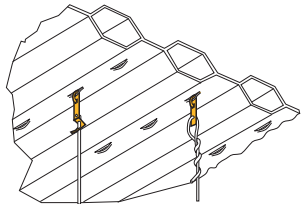
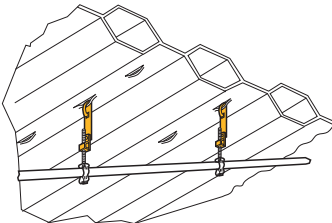

# Hangers / Hanging Systems

## Deck Hanger And Punch

### Features

- 1/4" or 3/8" square section nut or 3/8" (10 mm) clearance hole
- Maximum trapeze width 2" (50 mm)
- Minimum roof decking sheet thickness 24 gauge



Fig. #1

Part Number	Fig. #	Description	Standard Packaging Quantity
TDH	1	3/8" Plain Hole	50
TDHT4	2	1/4 - 20 Nut	50
TDHT6	2	3/8 - 16 Nut	50



Fig. #2

### Features

- Decking hole punch tool
- Easy one-step operation
- Preset dimensions
- No secondary power sources needed

Part Number	Fig. #	Description	Standard Packaging Quantity
TDHP2	3	Deck Hanger Punch	1
TDHP2PR10	4	Replacement Punch (requires 2 per punch)	1



Fig. #3

Roof Decking Thickness				
in	mm	gauge	lbs.	kN.
0.025-0.0276	0.63-0.70	24	130	0.60
0.0276-0.0315	0.70-0.80	23	150	0.70
0.0315-0.0394	0.80-1.00	22	180	0.80
0.0394	1.00	19	200	0.90
0.0516	1.20	18	240	1.07



Fig. #4





# Hangers / Hanging Systems

## Strap Hanger Clips

### Features

- Size Range: 1/8" – 3/4" Flange Thickness
- Supports pipe or duct from flange with banding or strapping
- The new clips are made from galvanized steel instead of spring steel. This expands the use to more applications, especially when used with other plated parts like the BC200 beam clamp
- Note: Pre-measure length of strap, hammer clip onto flange, then trapeze pipe or duct. Accepts strap up to 1-1/4" wide



Fig. #1

Part Number	Fig. #	Max. Rec. Load (lbs)	Flange Thickness (in)	Standard Packaging Quantity
MSS24	1	200	1/8 to 1/4	50
MSS58	1	200	5/16 to 1/2	50
MSS912	1	200	9/16 to 3/4	50
MSR24	2	200	1/8 to 1/4	50
MSR58	2	200	5/16 to 1/2	50
MSR912	2	200	9/16 to 3/4	50
MSSAFAB3	3	160	-	50



Fig. #2



Fig. #3



### Max. Recommended Load: 100 lbs

Part Number	Fig. #	Flange Thickness (in)	Standard Packaging Quantity
MSRBC200	1	1/8 to 5/8	50
MSSBC200	2	1/8 to 5/8	50



Fig. #1



Fig. #2

# Hangers / Hanging Systems

## CADDY® SPEED LINK

### Features

- Reduces installation time
- Quickly installs as a stand-alone hanging system without drilling into the building structure
- Works with a variety of CADDY® Fasteners
- Meets the fire rating requirements of DIN 4102-2 for 30 minutes (for galvanized wire rope) and 90 minutes (for stainless steel wire rope) at 30 percent of rated load
- Reduces inventory, storage space and shipping costs
- Increases installation versatility
- Minimizes vibration and system wear and tear
- Improves installation aesthetics
- Unique steel locking device allows for adjustment both during and after installation



Fig. #1



Fig. #2



Fig. #3



Fig. #4



Fig. #5



Many ERICO® products are UL Listed.  
Please contact your ERICO representative for approval information.

# Hangers / Hanging Systems

Part Number	Fig. #	Wire Rope Diameter		Wire Rope Length (Y Length)		Working Load		Standard Packaging Quantity
		mm	in	m	ft	kg	lbs	
<b>HOOK</b>								
SLD2L1	1	2.0	0.079	1	3.3	45	100	100
SLD2L2	1	2.0	0.079	2	6.6	45	100	100
SLD2L3	1	2.0	0.079	3	9.9	45	100	100
SLD2L5	1	2.0	0.079	5	16.4	45	100	50
SLD2L7	1	2.0	0.079	7	22.9	45	100	25
SLD2L10	1	2.0	0.079	10	32.8	45	100	25
SLD3L1	1	3.0	0.118	1	3.3	90	200	100
SLD3L2	1	3.0	0.118	2	6.6	90	200	100
SLD3L3	1	3.0	0.118	3	9.9	90	200	50
SLD3L5	1	3.0	0.118	5	16.4	90	200	50
SLD3L7	1	3.0	0.118	7	22.9	90	200	25
SLD3L10	1	3.0	0.118	10	32.8	90	200	25
<b>HOOK (Stainless Steel)</b>								
SLD3L2SS	1	3.0	0.118	2	6.6	90	200	100
SLD3L3SS	1	3.0	0.118	3	9.9	90	200	50
<b>Y-TOGGLE</b>								
SLD2Y300	2	2.0	0.079	(300 mm)	(11.8 in)	45	100	20
SLD2Y500	2	2.0	0.079	(500 mm)	(19.6 in)	45	100	20
<b>INTEGRAL Y-TOGGLE</b>								
SLD2Y300L2	3	2.0	0.079	2 (300 mm)	6.6 (11.8 in)	45	100	20
SLD2Y300L3	3	2.0	0.079	3 (300 mm)	9.9 (11.8 in)	45	100	20
SLD2Y300L5	3	2.0	0.079	5 (300 mm)	16.4 (11.8 in)	45	100	20
SLD2Y300L7	3	2.0	0.079	7 (300 mm)	22.9 (11.8 in)	45	100	20
SLD2Y300L10	3	2.0	0.079	10 (300 mm)	32.8 (11.8 in)	45	100	10
SLD2Y500L3	3	2.0	0.079	3 (500 mm)	9.9 (19.6 in)	45	100	20
<b>Y-HOOK</b>								
SLD2YH500	4	2.0	0.079	(500 mm)	(19.6 in)	45	100	10
SLD2YH800	4	2.0	0.079	(800 mm)	(31.4 in)	45	100	10
SLD3YH500	4	3.0	0.118	(500 mm)	(19.6 in)	90	200	10
SLD3YH800	4	3.0	0.118	(800 mm)	(31.4 in)	90	200	20
<b>INTEGRAL Y-HOOK</b>								
SLD2YH500L2	5	2.0	0.079	2 (500 mm)	6.6 (19.6 in)	45	100	20
SLD2YH500L3	5	2.0	0.079	3 (500 mm)	9.9 (19.6 in)	45	100	20
SLD2YH500L7	5	2.0	0.079	7 (500 mm)	22.9 (19.6 in)	45	100	20
<b>2-PACKS - INTEGRAL Y-HOOK</b>								
SLD2YH500L2TP	5	2.0	0.079	2 (500 mm)	6.6 (19.6 in)	45	100	1
SLD2YH500L3TP	5	2.0	0.079	3 (500 mm)	9.9 (19.6 in)	45	100	1
SLD2YH500L7TP	5	2.0	0.079	7 (500 mm)	22.9 (19.6 in)	45	100	1
<b>INDIVIDUALLY PACKAGED HOOK</b>								
SLD2L1BP	1	2.0	0.079	1	3.3	45	100	1
SLD2L2BP	1	2.0	0.079	2	6.6	45	100	1
SLD2L3BP	1	2.0	0.079	3	9.9	45	100	1
SLD2L5BP	1	2.0	0.079	5	16.4	45	100	1
SLD2L10BP	1	2.0	0.079	10	32.8	45	100	1
SLD3L1BP	1	3.0	0.118	1	3.3	90	200	1
SLD3L2BP	1	3.0	0.118	2	6.6	90	200	1
SLD3L3BP	1	3.0	0.118	3	9.9	90	200	1
SLD3L5BP	1	3.0	0.118	5	16.4	90	200	1
SLD3L10BP	1	3.0	0.118	10	32.8	90	200	1

# Hangers / Hanging Systems

## CADDY® SPEED LINK LD

### Features

- Ideal for lighting and other installation projects
- Cost-effective alternative to jack chain, threaded rod and associated hardware
- Safe working load of 20 kg (44 lbs.)
- 5:1 safety factor
- Sleek low-profile locking device reduces visual impact
- Adjustable after installation
- Available in stainless steel for applications where a higher level of corrosion resistance is required
- Works with a variety of CADDY® Fasteners
- Meets the fire rating requirements of DIN 4102-2 for 30 minutes (for galvanized wire rope) and 90 minutes (for stainless steel wire rope) at 30 percent of rated load



Fig. #1



Fig. #2



Fig. #3



Fig. #4



Fig. #5



Many ERICO® products are UL Listed.  
Please contact your ERICO representative for approval information.

Ph: 1-800-25-CADDY®  
www.erico.com

# Hangers / Hanging Systems

Part Number	Fig. #	Wire Rope Diameter		Wire Rope Length (Y Length)		Working Load		Standard Packaging Quantity
		mm	in	m	ft	kg	lbs	
<b>HOOK</b>								
SLD15L1	1	1.5	0.059	1	3.3	20	44	100
SLD15L2	1	1.5	0.059	2	6.6	20	44	100
SLD15L3	1	1.5	0.059	3	9.9	20	44	100
SLD15L5	1	1.5	0.059	5	16.4	20	44	100
SLD15L7	1	1.5	0.059	7	22.9	20	44	100
SLD15L10	1	1.5	0.059	10	32.8	20	44	100
<b>TOGGLE</b>								
SLD15L1T	2	1.5	0.059	1	3.3	20	44	20
SLD15L2T	2	1.5	0.059	2	6.6	20	44	20
SLD15L3T	2	1.5	0.059	3	9.9	20	44	20
SLD15L5T	2	1.5	0.059	5	16.4	20	44	20
SLD15L7T	2	1.5	0.059	7	22.9	20	44	20
SLD15L10T	2	1.5	0.059	10	32.8	20	44	20
<b>Y-TOGGLE</b>								
SLD15Y200	3	1.5	0.059	(200 mm)	(7.8 in)	20	44	20
SLD15Y300	3	1.5	0.059	(300 mm)	(11.8 in)	20	44	20
SLD15Y500	3	1.5	0.059	(500 mm)	(19.6 in)	20	44	20
SLD15Y800	3	1.5	0.059	(800 mm)	(31.4 in)	20	44	20
<b>INTEGRAL Y-TOGGLE</b>								
SLD15Y300L3	4	1.5	0.059	3 (300 mm)	9.9 (11.8 in)	20	44	20
SLD15Y300L5	4	1.5	0.059	5 (300 mm)	16.4 (11.8 in)	20	44	20
<b>QUAD TOGGLE</b>								
SLD15QT250	5	1.5	0.059	(250 mm)	(9.8 in)	20	44	20
<b>2-PACKS - HOOK</b>								
SLD15L1TP	1	1.5	0.059	1	3.3	20	44	1
SLD15L2TP	1	1.5	0.059	2	6.6	20	44	1
SLD15L3TP	1	1.5	0.059	3	9.9	20	44	1
SLD15L5TP	1	1.5	0.059	5	16.4	20	44	1
<b>2-PACKS - HOOK Stainless Steel</b>								
SLD15L2S	1	1.5	0.059	2	6.6	20	44	40
SLD15L5S	1	1.5	0.059	5	16.4	20	44	40
SLD15L10S	1	1.5	0.059	10	32.8	20	44	40
<b>2-PACKS - TOGGLE</b>								
SLD15L1TTP	2	1.5	0.059	1	3.3	20	44	1
SLD15L2TTP	2	1.5	0.059	2	6.6	20	44	1
SLD15L3TTP	2	1.5	0.059	3	9.9	20	44	1
SLD15L5TTP	2	1.5	0.059	5	16.4	20	44	1
SLD15L10TTP	2	1.5	0.059	10	32.8	20	44	1
<b>2-PACKS - Y-TOGGLE</b>								
SLD15Y500TP	3	1.5	0.059	(500 mm)	(19.6 in)	20	44	1
SLD15Y800TP	3	1.5	0.059	(800 mm)	(31.4 in)	20	44	1

# Hangers / Hanging Systems

## CADDY® SPEED LINK Tools & Accessories

Part Number	Fig. #	Description	Standard Packaging Quantity
SL1214	1	CADDY SPEED LINK Clip .468 - .562 MC/AC Cable	100
SL1518	1	CADDY SPEED LINK MC/AC Clip 0.500" – 0.718"	100
SLADCP	2	CADDY SPEED LINK Air Duct Corner Protector	10
SLADS	3	CADDY SPEED LINK Screw-on Air Duct Angle Support	100
SLEB250	4	Eye Bolt 1/4-20 x 1-3/16"	100
SLEB375	4	Eye Bolt 3/8-16 x 1-9/16"	100
SLEBM6*	4	Eye Bolt M6; 30 mm long	100
SLEBM8*	4	Eye Bolt M8; 40 mm long	100
SLEBWS	4	Eye Bolt Wood Screw H6 x 2-3/8"	100
SLLC250*	5	CADDY SPEED LINK Lighting clip 1/4 inch	200
SLWC	6	CADDY SPEED LINK Wire Cutter	1
SLWPT	7	CADDY SPEED LINK Wire Insulation Protection Tube, 82 ft	82

\*50 pound (22 Kg) ultimate static load limit. Not to be used as a lifting device.



Fig. #1



Fig. #2



Fig. #3



Fig. #4



Fig. #5



Fig. #6



Fig. #7



# Hangers / Hanging Systems

## Installation tool for VF & AF assemblies

Part Number	Description	Standard Packaging Quantity
VAFT	Installation tool for VF & AF assemblies (1/2" conduit not included)	1



# CADDY® SPEED LINK

## Another Bright Idea From CADDY®

CADDY®, the name you trust for simplified lighting installations, has done it again.

### Versatile

Choose from an expanded variety of CADDY® SPEED LINK toggles, hooks and loops that will help you save even more time and labor during your installations.

### Convenient

With one all-inclusive system you'll have everything you need to quickly and easily hang basket tray, light fixtures, speakers, wireless access points and other equipment.

### Features

- Diameters available: .059 in to .118 in
- Lengths available: 3 ft to 30 ft (approx.)
- Connection types: Toggles, hooks and loops
- Safety: 5-to-1 safety factor; complies with codes, standards and best practices
- Environmentally friendly: Uses less material than standard installation methods

When efficiency and simplicity are essential to your installation, choose from a wide selection of CADDY SPEED LINK accessories.





# Stud Wall



# Stud Wall

## Box Mounting Bracket For Electrical Box

### Features

- Easily attaches 4" and 4 11/16" outlet boxes to metal stud (HS3 for switch boxes)
- Support leg reduces movement of box in wall
- Can be attached to metal or wood stud
- Offset design and use of #SMS8 low profile self-tapping screws (not included) reduce dry wall bulge



Fig. #1



Part Number	Fig. #	Application	Box Size	Stud Depth (in)	Standard Packaging Quantity
H23	1	U.S.	4 in sq. & 4-11/16 in	2 1/2 & 3 1/2	100
H23TC	1	Canada	4 in sq. & 4-11/16 in	2 1/2 & 3 1/2	100
H4	1	U.S.	4 in sq. & 4-11/16 in	4	50
H46TC	1	Canada	4 in sq. & 4-11/16 in	4 & 6	100
H6	1	U.S.	4 in sq. & 4-11/16 in	6	50
HS3	2	U.S. & Canada	Switch	2 1/2 & 3 1/2	100

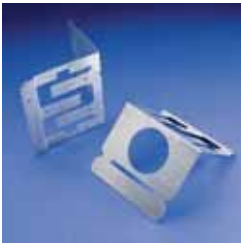

Fig. #2



# Stud Wall

## Screw On Conduit Support



### Features

- Accommodates 1/2", 3/4" and 1" EMT, Conduit and MC/AC Cable
- Alignment tab positively locates the fastener on the stud, keeping your conduit in line with box knock out and H-series brackets
- For wood or metal stud
- Delivers compliance with: NEC Article 358.30(A) which requires conduit support within 36" of an electrical box. CEC Rule 12-1404 which requires conduit support within 1 m (36") of an electrical box. CEC Rule 12-618 which requires support of armoured cable within 300 mm (12") of an electrical box

Part Number	Description	Standard Packaging Quantity
CS812	Screw on Conduit Support; attaches 1/2" and 3/4" EMT, conduit, MC/AC to metal or wood stud For 1 1/2 deep box	100
CS812D	Screw on Conduit Support; attaches 1/2" and 3/4" EMT, conduit, MC/AC to metal or wood stud For 2 1/8 deep box	100
CS16	Screw on Conduit Support; attaches 1" EMT, conduit, MC/AC to metal or wood stud For 2 1/8" deep box	100

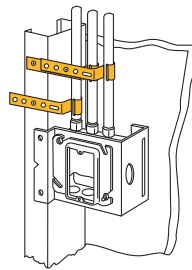

Eliminates offset bending of conduit

# Stud Wall

## "Mounts Electrical Boxes" Hanger

### Features

- One bracket works for: Two box depths (1 1/2" or 2 1/8" deep) Two box sizes (4" or 4 11/16" sq.) Three wall stud depths (2 1/2", 3 1/2" & 4" studs)
- All-in-one design simplifies handling, reduces inventory and saves space
- Requires only a screw gun to install
- V-notched on center allows for consistent positioning
- Built-in support legs reduce box movement when used with EMT and is ideal for flexible conduit, MC, AC or Romex® non-metallic sheathed cable
- Offset design of MEB1 and use of #SMS8 low profile self-tapping screws (not included) reduce drywall bulge
- Can be pre-assembled in the shop to allow for greater efficiency at the job site
- Plaster rings can be mounted separately eliminating the need for an electrical box for low-voltage applications
- MP Series brackets can be attached in-line to the MEB1 for low voltage applications
- Mounts on either side of stud without need to reposition box



One-Piece Design

### One Size Fits All

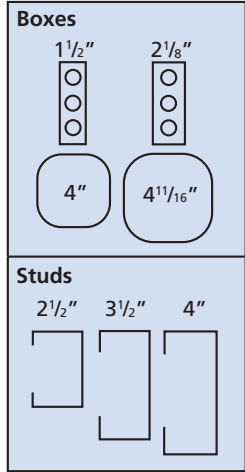

Part Number	Description	Standard Packaging Quantity
MEB1	"Mounts Electrical Boxes" Hanger	25



# Stud Wall

## Press-On Nail Plate

### Features

- Fast press-on installation; no tools required
- Protects electrical, datacomm and plumbing
- Works on wood or metal studs
- Meets NEC 300.4(b)(2). Also Designed to meet CEC 12-516 and 12-616
- Breakable tabs permit multiple plates to be ganged together
- Corrosion resistant zinc phosphate coating



Part Number	Description	Standard Packaging Quantity
304B2	Press-on Wood/Metal Stud Protection Plate	100

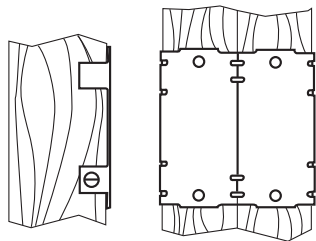
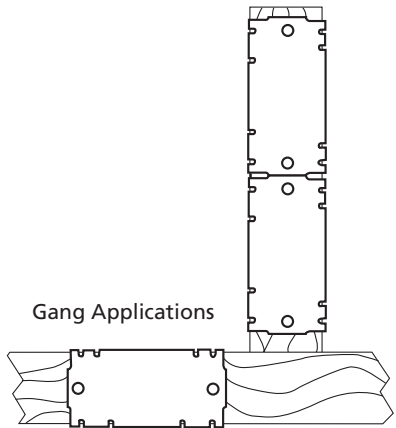

Side View

Face View

# Stud Wall

## Snap On Box Supports for Metal/Wood Studs

### Features

- Spring steel for press-on attachment
- Center hole assists in consistent alignment, exact positioning and screw attachment
- MSF requires hammer to attach clip to box. DBM2 attaches without hammer

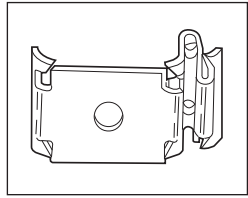

Fig. #1

Part Number	Fig. #	Description	Standard Packaging Quantity
MSF	1	Box support to outside of stud	100
DBM2	2	Double box mount support	50

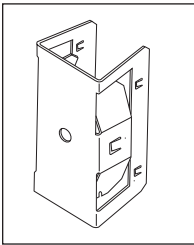
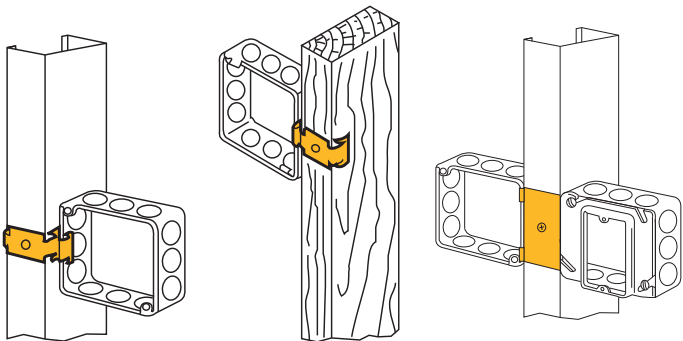
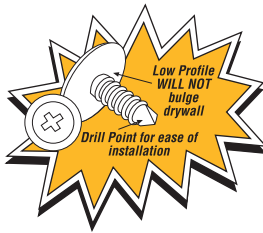

Fig. #2



# Stud Wall

## Adjustable Far Side Box Support

### Features

- Provides far side electrical box support in various stud wall depths
- Installs in seconds with simple tools: pliers for 766A, hammer for J1A35



Fig. #1

**Note:** No Load Rating - Positioning Only

Part Number	Fig. #	Description	Standard Packaging Quantity
J1A35	1	Adjustable Far Side Box Support -Hammer on for 2 1/2" and 3 1/2" studs	100
766	2	Adjustable Far Side Box Support -Lock on for 2 1/2", 3 1/2" and 4" studs	100
766A	3	Adjustable Far Side Box Support -Snap on for 2 1/2", 3 1/2", 4" & 6" studs	100



Fig. #2



Fig. #3

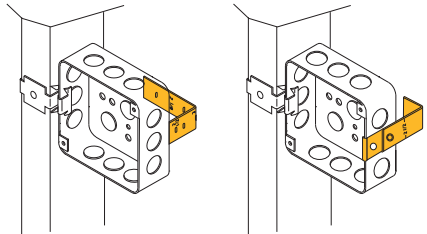

# Stud Wall

## Switch Box Or Conduit To Metal Stud

### Features

- Allows the switch box to protrude through any size dry wall – 1/4", 3/8", 1/2", 5/8" or 3/4"
- Fits most dry wall studding
- Fits most switch boxes  
- Figure 1, 4, and 5 only



Fig. #1

Part Number	Fig. #	Description	Standard Packaging Quantity
MF1	1	1/4"-20 Thread impression	100
MFS	2	With screw (adjustable 1/4" thru 3/4")	100
MFO	3	Riveted flush to stud face	100
MF250	3	Riveted for 1/4" dry wall	100
MF375	3	Riveted for 3/8" dry wall	100
MF500	3	Riveted for 1/2" dry wall	100
MF625	3	Riveted for 5/8" dry wall	100
MF750	3	Riveted for 3/4" dry wall	100
6MF	4	3/8" Conduit or BX to metal stud	100
812MF	4	1/2" to 3/4" Conduit to metal stud	100
16MF	4	1" Conduit to metal stud	100
8PF	5	1/2" Conduit to metal stud	100
12PF	5	3/4" Conduit to metal stud	100
16PF	5	1" Conduit to metal stud	100



Fig. #2



Fig. #3



Fig. #4



Fig. #5





# Stud Wall

## Screw On Box Support

### Features

- Permits positioning of metal electrical box anywhere on metal or wood stud, regardless of stud size
- The 350 is securely held in place with screws



Fig. #1

Part Number	Fig. #	Description	Standard Packaging Quantity
350	1	For 4" electrical box to metal stud	100
350812M	2	For 1/2" or 3/4" conduit to metal stud	100
35016M	2	For 1" conduit to metal stud	100
3508P	3	For 1/2" conduit to metal stud	100
35012P	3	For 3/4" conduit to metal stud	100
35016P	3	For 1" conduit to metal stud	100



Fig. #2



Fig. #3

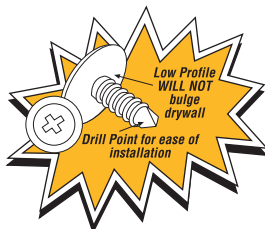
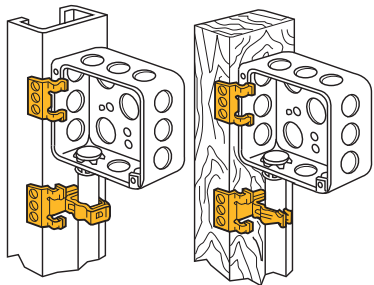

# Stud Wall

## Box Mounting Brackets For Between Studs

### Features

- Accommodates up to four 4" or 4 11/16" boxes
- Eliminates the need for an electrical box on low voltage applications
- Mounts 1 1/2" or 2 1/8" deep boxes
- Supports electrical boxes, plaster rings or low voltage devices from one bracket



Fig. #1

Part Number	Fig. #	Description	Standard Packaging Quantity
RBS16	1	Between Stud Box Mounting Brackets -Mounts up to three 4" or 4 11/16" boxes/plaster rings, 16" bracket	25
RBS24	2	Between Stud Box Mounting Brackets -Mounts up to four 4" or 4 11/16" boxes/plaster rings, 24" bracket	25



Fig. #2



# Stud Wall

## Screw Gun Box Bracket For Between Studs

### Features

- Can mount multiple 1-1/2" or 2-1/8" deep boxes. Notched and marked for easy identification and bending
- Improved design with stamped inch markings and pilot holes accelerates precise box conduit mounting between studs
- Pilot holes allow easy box attachment with a screwdriver
- Requires only a screw gun to install
- Reduces movement of the box when used with flexible conduit, ENT, MC, AC or ROMEX®
- Can be mounted to face or inside of stud
- No more time-consuming field fabrication with scrap floor track.
- Adjustable for non-standard stud spacing
- Interlocking tab prevents accidental disassembly.
- Unique, one-piece, break apart design



Fig. #1

Part Number	Fig. #	Description	Box Depth (in)	Standard Packaging Quantity
TSGB16	1	Telescoping Screw Gun Bracket 11" to 18" Stud Spacing	1 1/2 & 2 1/8	50
TSGB24	1	Telescoping Screw Gun Bracket 17" to 26" Stud Spacing	1 1/2 & 2 1/8	50

- Can be pre-assembled by the contractor to allow for greater productivity at the job site
- Pre-set for studs 16" or 24" on center



Fig. #2

Part Number	Fig. #	Description	Box Depth (in)	Standard Packaging Quantity
SGB16A*	2	Screw Gun Bracket 16" Stud Spacing	1 1/2 & 2 1/8	50
SGB24A†	2	Screw Gun Bracket 24" Stud Spacing	1 1/2 & 2 1/8	50

\*Replaces SGB16 & SGB16D

†Replaces SGB24 & SGB24D

# Stud Wall

## Floor Mounted Box/ Conduit Supports

### Features

- FB series supports electrical boxes from floor or concrete forms
- Available in 12", 16" and 18" heights
- Slot provides for 8" height adjustment
- Use FBS with CCS812 to support conduits in concrete pours
- CCS812 eliminates offset bending of conduit
- CCS812 also works with TSGB and SGB

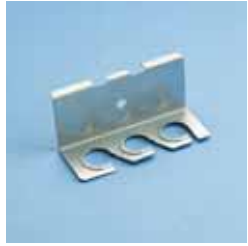

Fig. #1



Fig. #2



Part Number	Fig. #	Description	Standard Packaging Quantity
CCS812	1	Conduit bracket- floor support- 1/2" or 3/4" EMT - 1/2" RIGD	100
FBS12	2	Floor support- for 12" High box	50
FBS16	2	Floor support- for 16" High box	50
FBS18	2	Floor support- for 18" High box	50



# Stud Wall

## FMBS18

### Features

- Positions center of electrical box 18 1/2" above unfinished floor
- Meets ADA (Americans with Disabilities Act) accessibility Guidelines Standards (15" height minimum for "forward reach" from a wheelchair)
- Quick, easy and efficient compliance to construction requirements
- Mounts 4" or 4 11/16" U.S. or Canadian boxes; 1 1/2" or 2 1/8" deep
- Mounts plaster rings for low voltage applications
- Mounts inside (use mounting tabs) or under floor track
- Versatile positioning - independent of wall stud location
- Built-in far-side back support for 2 1/2", 3 1/2", and 4" metal or wood studs
- Reduces stocking different size brackets
- Accommodates additional brackets for multiple box and device mounting



Part Number	Description	Standard Packaging Quantity
FMBS18	Floor Mount Box Support	25



# Stud Wall

## Low Voltage Mounting Bracket For New Construction

### Features

- Provides a bracket for mounting low voltage Class 2 communication outlets
- Reduces bulges in the dry wall caused by plaster rings
- May be installed to the front or the side of the metal or wood stud
- Side support provides for a rigid installation
- Attaches with self-tapping screws or nails
- Works with 1/2" and 5/8" dry wall
- Works with wood or metal studs



Fig. #1



Fig. #2

**Notes:** No Load Rating - Positioning Only

Part Number	Fig. #	Description	Standard Packaging Quantity
MP1S	1	Single gang plate mounting bracket for new work	25
MP2S	2	Double gang plate mounting bracket for new work	25



# Stud Wall

## Cable Gripper

### Features

- Attaches to existing holes in metal studs without tools or with Metal Stud Punch (MSP20)
- Delivers compliance with: NEC 300.4(d), CEC 12-510 and 12-516
- Installs easily to metal and wood studs
- Provides secure installation of multiple cables with unique locking/unlocking system
- Staples, nails or screws to wood stud
- Supports four NMC or eight 4-pair UTP, Category 5 and higher (electrical and datacomm cannot be combined)



Patent Number:  
5,626,316



Part Number	Description	Bag Qty
CG4	Cable Gripper cable support	100



Refer to part number  
MSP20 for the Metal  
Stud Punch

# Stud Wall

## "Colorado Jim" Cable Support

### Features

- Easy-to-use locking tab
- Cable locating ribs to maintain cable separation
- Flared edges for cable protection
- NEC 300.4D applicable
- For wood or metal stud

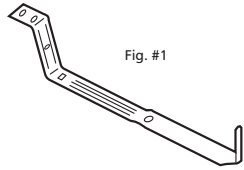

Fig. #1

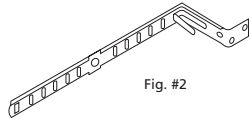
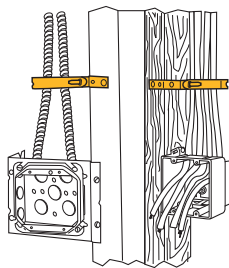

Fig. #2

Part Number	Fig. #	Description	Standard Packaging Quantity
CJ6	1	Cable support- Non-metallic or metal clad to wood or metal stud	100
CJ6IN*	1	Cable Support with insulation	100
CJ6S	2	AC or Flexible Cable to Furring strip and hat channel	100

\*Used only in Canada

PART NUMBER	CABLE TYPE	CABLE SIZE	CABLES PER FASTENER
CJ6 to Wood	Non-Metallic	14-2, 12-2, 10-2, 14-3, 12-3 and 10-3 w/ground	6 maximum
		8-2 and 6-2 w/ground	4 maximum
CJ6 to Metal Stud	Metal Clad (MC) Cable	14-2, 12-2, 10-2, 14-3, 12-3, 10-3, 14-4, 12-4 and 10-4 w/ground	4 maximum
CJ6S to Furring Strip and Hat Channel	Armored Cable (AC)	14-4, 12-2, 10-2, 8-2, 14-3, 12-3, 10-3, 14-4, 12-4 and 10-4 w/ground	4 maximum
	Flexible Conduit (BX)	5/16, 3/8	4 maximum
<b>USED ONLY IN CANADA</b>			
CJ6IN to Metal Stud	Non-Metallic Sheathed Cable	14-2, 12-2, 10-2, 14-3, 12-3 and 10-3 w/ground	4 maximum





# Stud Wall

## ROMEX® NMC And MC/AC Cable Support For Studs



### Features

- Delivers compliance with: NEC 300.4(d), CEC 12-618 and CEC 12-510
- No installation tools required
- Provides secure support of NMC or MC/AC to metal/wood stud in seconds. One fastener, four applications



Part Number	Description	Standard Packaging Quantity
FXC20	NMC sizes 14-2 with ground thru 12-3 with ground MC/AC cable sizes 14-2 thru 12-3 to studs	100

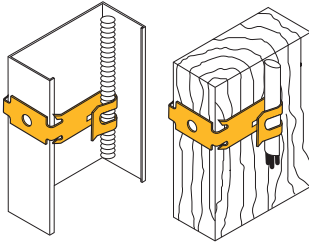

**Note:** When supporting NMC in Canada, FXC20 can only be used on wood stud.

## Anti-Rattle Support

### Features

- Permits ENT, MC and AC to be pulled thru metal stud
- Requires a self-tapping screw to install
- Supports ENT, MC/AC, EMT or rigid conduit up to 1"

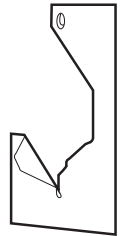

Part Number	Description	Standard Packaging Quantity
781	Anti-Rattle Stud Support - conduit up to 1"	100

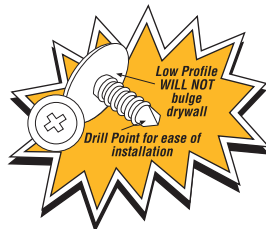

# Stud Wall

## Metal Stud Punch And Easy Snap Grommet

### Features

- Cushioned handles mean less operator fatigue and more comfortable handling
- Tool design with offset handles allows punch to work in confined locations and near perpendicular walls
- Lightweight punch makes accurate location of holes easier
- Hardened steel components keep tool sharper longer – less replacement
- Punches up to 20 gauge sheet metal
- Plastic grommets snap easily into 1-11/32" hole



Fig. #1



Part Number	Fig. #	Description	Standard Packaging Quantity
MSP20	1	Metal Stud Punch	1

### Features

- Snap one grommet into standard 1-11/32" field punched hole, OR snap tight two together into any shape factory punched hole
- Provides 360° protection for cable and makes cable pulls easier



Fig. #2

Part Number	Fig. #	Description	Standard Packaging Quantity
ESG1	2	Metal Stud Grommet	100
ESG1M	2	Metal Stud Grommet	1,000
ESGP	3	Metal Stud Anti-Rattle Grommet	100
ESGPM	3	Metal Stud Anti-Rattle Grommet	1,000



Fig. #3



# Stud Wall

## Through Stud Cable/Conduit Support

### Features

- Eliminates conduit rattling
- Provides a quick means of support for horizontal runs of Rigid, EMT, MC/AC or ENT through metal stud



Fig. #1



Fig. #2

### “Florida Bob” Series

- Available with 812M snap shut conduit support, as well as push in conduit support
- Installs with screw gun

Part Number	Fig. #	Description	Standard Packaging Quantity
FB6M	1	Through Stud Cable/Conduit Support for MC/AC	100
FB812M	1	Through Stud Cable/Conduit Support for 1/2" or 3/4" Conduit	100
FB8P	2	Through Stud Cable/Conduit Support for 1/2" Conduit	100
FB12P	2	Through Stud Cable/Conduit Support for 3/4" Conduit	100

### 459/AR812

- One-piece spring steel design snaps onto stud

Part Number	Fig. #	Description	Standard Packaging Quantity
459	3	Through Stud Cable/Conduit Support for MC/AC (14-2, 14-3, 12-2, or 12-3)	100
AR812	3	Through Stud Cable/Conduit Support for: 1/2" and 3/4" EMT Conduit 1/2" Rigid, IMC, PVC Sch 40 5/8" and 3/4" Copper Tube MC/AC .700 - .925 O.D.	100



Fig. #3

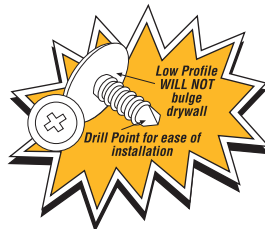

# Stud Wall

## Metal Screws

### Features

- Minimizes drywall bulge.
- Self-drilling and tapping.



Part Number	Description	Standard Packaging Quantity
SMS8	#8 x 1/2 low profile- self drilling and tapping screw	1,000

**Notes:** Use to mount CADDY® Fasteners in all metal stud applications.



# Drywall



# Drywall

## Old Work Box Mount

### Features

- One-piece, break-apart design is easy to handle
- Works on drywall, lathe and plaster; only a drywall saw required



Fig. #1

Part Number	Fig. #	Description	Wall Thickness (in)	Standard Packaging Quantity
DSI2A	1	Old work box mount	Up to 1-1/2	100

### DSB

- One-piece, break-apart design is easy to handle
- Works on drywall, lathe and plaster; only a drywall saw required
- Accommodates single or multiple gang boxes; for multiple gang boxes use (2) DSB's.
- Can be placed at different locations on an electrical box to allow for more clearance.
- Fastener installs before the box to free up your hands.



Fig. #2

Part Number	Fig. #	Description	Wall Thickness (in)	Standard Packaging Quantity
DSB	2	Old work box mount	1/4 to 1-1/4	100

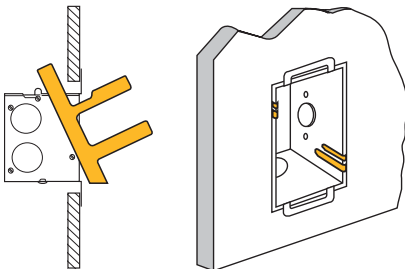

# Drywall

## Device Leveler And Retainer

### Features

- Use for oversize dry wall openings
- Helps prevent broken cover plates
- Helps prevent device from being pushed back in wall
- Makes floating device rigid



Part Number	Description	Standard Packaging Quantity
RLC	Device leveler and retainer	100



## Versatile Thread Impression

### Features

- Support point for speakers, audio/video/security panels, EXIT signs, etc
- Works in 1/2" and 5/8" drywall
- Use either #6-32 screw or #6 sheet metal screw
- Spring steel with corrosion protection finish



Part Number	Description	Standard Packaging Quantity
MPVTI	Versatile thread impression	20



# Drywall

## Mounting Plate Brackets (Non-Metallic)

### Features

- No sharp metal edges with plastic design
- Fast, easy way to install
- No installation tools required to secure bracket in the drywall opening
- Serrated interlocking system secures tightly
- Template points on brackets help eliminate multiple measurement markings during installation
- Recessed design helps assure flush mount of device
- Only CADDY® provides the industry with the widest application range 1/4" to 1 1/4" wall thickness
- Available in single gang, double gang and a unique 3-4 gang sizes
- Eliminates the need for electrical boxes on low voltage class 2 applications



Fig. #1

**Notes:** For low voltage Class 2 use only.; No Load Rating - Positioning Only

Part Number	Fig. #	Description	Standard Packaging Quantity
MP1P	1	Non-Metallic Single gang mounting plate	100
MPAL2	2	Non-Metallic double gang mounting plate	100
MP34P	3	Non-Metallic 3 or 4 gang mounting plate	2



Fig. #2



Fig. #3





# Drywall

## Mounting Plate Brackets (Metallic)

### Screw-On Support

#### Features

- Provides positive support with locking screws
- Mounts any standard low voltage device in 1/2" through 1 1/4" walls
- Makes wire "fishing" easier
- Install with a drywall saw and screwdriver
- Eliminates the need for an electrical box when installing low voltage Class 2 wiring



Fig. #1

**Notes:** For low voltage Class 2 use only.

Part Number	Fig. #	Description	Standard Packaging Quantity
MP1	1	Single gang Mounting Plate Brackets (no screws included)	100
MPLS	2	Single gang Mounting Plate Brackets screws to drywall (screws included)	100
MPLS2	3	Double gang Mounting Plate Brackets screws to drywall (screws included)	100



Fig. #2



Fig. #3

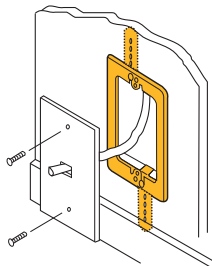

## Innovative Ideas

ERICO® Research and Development is continually working with contractor suggestions to develop new fasteners and improve the current product offering. Thanks to your help, our focus on continuous product innovation is moving forward. Your suggestions have resulted in exciting improvements to many of our existing fasteners. In fact, the majority of CADDY® Fasteners are the result of providing solutions for customers' problems.

We always welcome your ideas and suggestions. To submit an idea go to [www.erico.com](http://www.erico.com).

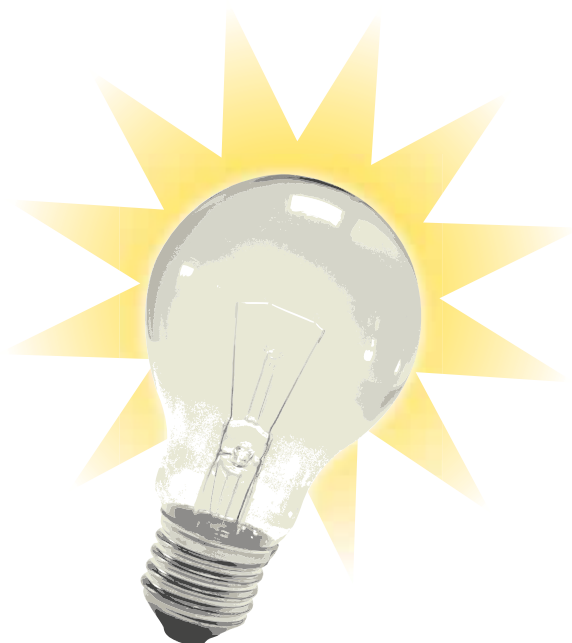

# Datacomm / ITS



## CADDY® CAT LINKS

Patent Pending

### Features

- Provides proper support of high performance cabling (Category 6a and higher)
- CADDY® fasteners easily attach to any size CADDY CAT LINKS J-hook
- cULus® Listed and complies with NEC® and TIA<sup>SM</sup> requirements for structured cabling systems
- Cost effective alternative to expensive cable tray
- Pre-galvanized J-hooks provide smoother cable pull and greater corrosion resistance

Part Number	Fig. #	Description	Standard Packaging Quantity
CAT16HP	1	1" J-hook designed for CAT6a and higher cabling	50
CAT32HP	1	2" J-hook designed for CAT6a and higher cabling	50
CAT48HP	1	3" J-hook designed for CAT6a and higher cabling	25
CAT64HP	1	4" J-hook designed for CAT6a and higher cabling	25
CATHPA4	2	CATHP Angle Bracket with 1/4" hole	50
CATHPA6	2	CATHP Angle Bracket with 3/8" hole	50
CATHPAN	2	CATHP Angle Bracket with 3/16" hole	50
CATHP54	3	CATHP Straight Bracket with 3/8" hole	50
CATHPMTM	4	CATHP Tree Mounting Bracket	50
CATHP24	5	CATHP Angle Bracket riveted to a CM24	25
CATHP58	5	CATHP Angle Bracket riveted to a CM58	25
CATHP912	5	CATHP Angle Bracket riveted to a CM912	25
CATHPBCB	6	CATHP Angle Bracket riveted to a BC	25
CATHPBC200B	7	CATHP Angle Bracket riveted to a BC200	25
CATHP24SM	8	CATHP Straight Bracket riveted to a 4H24	50
CATHP58SM	8	CATHP Straight Bracket riveted to a 4H58	50
CATHP912SM	8	CATHP Straight Bracket riveted to a 4H912	25
CATHPBC	9	CATHP Straight Bracket riveted to a BC	50
CATHPBC200	10	CATHP Straight Bracket riveted to a BC200	25
CATHPAF14	11	CATHP Straight Bracket riveted to an AF14	50
CATHPVF14	12	CATHP Straight Bracket riveted to a VF14	50
CATHPESC	13	CATHP Straight Bracket riveted to an ESC	50
CATHP4Z34	14	CATHP Straight Bracket riveted to a 4Z34	50
CATHP6Z34	14	CATHP Straight Bracket riveted to a 6Z34	50
CATHPCD0B	15	CATHP Straight Bracket riveted to a CD0B	25
CATHPCD1B	15	CATHP Straight Bracket riveted to a CD1B	25
CATHPCD2.5B	15	CATHP Straight Bracket hole riveted to a CD2.5B	25
CATHPCD2B	15	CATHP Straight Bracket riveted to a CD2B	25
CAT16HPTS	16	1" J-hook riveted to a T-Bar bracket	2
CATHPPLR	17	Pulley kit for CADDY CAT LINKS	2





Fig. #1



Fig. #2



Fig. #3



Fig. #4



Fig. #5



Fig. #6



Fig. #7



Fig. #8



Fig. #9



Fig. #10



Fig. #11



Fig. #12



Fig. #13



Fig. #14



Fig. #15



Fig. #16



Fig. #17

See page 154  
for the complete  
CADDY® CABLECAT  
Capacity Guide

## CADDY® CABLECAT

### Wide Base Cable Support

#### Features

- Provides proper support of Category 5e, Category 6, fiber optic and innerduct
- Many sizes and designs available to attach to a variety of structures.
- Cost effective alternative to expensive cable tray
- Galvanized finish on J-hooks provide smoother cable pull and greater corrosion resistance.
- cULus® listed and complies with NEC® and TIA<sup>SM</sup> requirements for structured cabling systems

Patent Number: 5,740,994

Part Number	Fig. #	Description	Standard Packaging Quantity
CAT12	1	J-hook that accepts up to 16 4-pair UTP CAT 5e or 2-strand fiber optic cable, or 10 CAT 6 - 3/4" dia	50
CAT21*	1	J-Hook that accepts up to 50 4-pair UTP CAT 5e or 2-strand fiber optic cable or innerduct, or 32 CAT	80
CAT32*	1	J-Hook that accepts up to 80 4-pair UTP CAT 5e or 2-strand fiber optic cable or innerduct, or 50 CAT	60
CAT64	1	J-Hook that accepts up to 300 4-pair UTP CAT 5e or 2-strand fiber optic cable, or 185 CAT 6 - 4" dia	25
CATHBA	2	Extended J-Hook angle bracket - 1/4" mounting hole	40
CATHBA3 <sup>†</sup>	3	Extended J-Hook angle bracket - 3/16" mounting hole	40
CATHBA6	3	Extended J-Hook angle bracket - 3/8" mounting hole	40
CATHBA8	3	Extended J-Hook angle bracket - 1/2" mounting hole	40
CATKITA	4	CAT32 – 20 pieces; CATHBA Hanger – 5 pieces; BC200 Beam Clamps – 5 pieces	1
CATKITB	4	CAT21 – 10 pieces; CAT32 – 10 pieces; CATHBA Hanger – 5 pieces; BC200 Beam Clamps – 5 pieces (screws included)	1
CATKITC	4	CAT21 – 20 pieces; CATHBA Hanger – 5 pieces; BC200 Beam Clamps – 5 pieces (screws included)	1
CATTS	5	Support from tee grid	100

\*Available in Stainless Steel

<sup>†</sup>Load limits apply to CADDY® fasteners only.

Pin must be evaluated separately.





Fig. #1



Fig. #2



Fig. #3



Fig. #4



Fig. #5



See page 154  
for the complete  
CADDY® CABLECAT  
Capacity Guide

## Metal Screws

### Features

- For CADDY® CABLECAT Wide Base Cable Support.

Part Number	Description	Standard Packaging Quantity
S3575BP100	1/4- 20 x 3/8" round head screw	100
S3575DP100	1/4- 20 x 3/4" round head screw	100

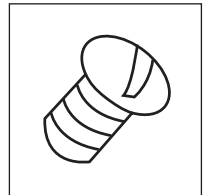

## CADDY® CABLECAT

Patent Number: 5,740,994

Wide Base Cable Support Clips -  
3/4" Diameter Loop



Part Number	Fig. #	Description	Standard Packaging Quantity
CAT124Z34	1	3/4" J-Hook assembled to 4Z34 - #12 thru 1/4" wire, plain or threaded rod and 1/8" thru 3/8" flange	40
CAT126Z34	1	3/4" J-Hook assembled to 6Z34 - 3/8" plain or threaded rod and 3/8" thru 7/16" flange	60
CAT12TS	2	3/4" J-Hook assembled to Acoustical tee bar bracket	60
CAT12AB	3	3/4" J-Hook assembled to angle bracket - 1/4" mounting hole	40
CAT12AFAB3	4	3/4" J-Hook assembled to Angle Bracket Assembly - 3/16" mounting hole	40
CAT12VF14	5	3/4" J-Hook assembled to C purlin bracket - 1/16" thru 1/4" vertical flange	40
CAT12912SM	6	3/4" J-Hook assembled to hammer-on 1/2" thru 3/4" flange - side mount	40
CAT12912	7	3/4" J-Hook assembled to hammer-on 1/2" thru 3/4" flange - bottom mount rotates 360°	20
CAT1224SM	6	3/4" J-Hook assembled to hammer-on 1/8" thru 1/4" flange - side mount	40
CAT1224	7	3/4" J-Hook assembled to hammer-on 1/8" thru 1/4" flange - bottom mount rotates 360°	40
CAT1258SM	6	3/4" J-Hook assembled to hammer-on 5/16" thru 1/2" flange - side mount	40
CAT1258	7	3/4" J-Hook assembled to hammer-on 5/16" thru 1/2" flange - bottom mount rotates 360°	40
CAT12BC	8	3/4" J-Hook assembled to screw-on bracket - 1/8" thru 1/2" flange	40
CAT12BC200	9	3/4" J-Hook assembled to screw-on bracket - 1/8" thru 5/8" flange	40
CAT12BC200B	10	3/4" J-Hook assembled to screw-on bracket - 1/8" thru 5/8" flange - rotates 360°	40
CAT12BCB	8	3/4" J-Hook assembled to screw-on bracket 1/8" thru 1/2" flange - rotates 360°	40
CAT12CD1B	11	3/4" J-Hook assembled to under floor support to pedestal	40
CAT12AF14	12	3/4" J-Hook assembled to Z purlin bracket - 1/16" thru 1/4" Z purlin	40
CAT12ESC	13	Snap-in 3/4" Diameter J-Hook	60



Many ERICO® products are UL Listed.  
Please contact your ERICO representative for approval information.





Fig. #1



Fig. #2



Fig. #3



Fig. #4



Fig. #5



Fig. #6



Fig. #7



Fig. #8



Fig. #9



Fig. #10



Fig. #11



Fig. #12



Fig. #13

See page 154  
for the complete  
CADDY® CABLECAT  
Capacity Guide

## CADDY® CABLECAT

Patent Number: 5,740,994

Wide Base Cable Support Clips  
- 1 5/16" Diameter Loop



Part Number	Fig. #	Description	Standard Packaging Quantity
CAT214Z34	1	1-5/16" J-Hook assembled to 4Z34 - #12 thru 1/4" wire, plain or threaded rod and 1/8" thru 3/8" flange	40
CAT216Z34	1	1-5/16" J-Hook assembled to 6Z34 - 3/8" plain or threaded rod and 3/8" thru 7/16" flange	60
CAT21AB	2	1-5/16" J-Hook assembled to angle bracket - 1/4" mounting hole	40
CAT21AFAB3	3	1-5/16" J-Hook assembled to Angle Bracket Assembly - 3/16" mounting hole	40
CAT21AFAB4	3	1-5/16" J-Hook assembled to Angle Bracket Assembly - 1/4" mounting hole	40
CAT21AFAB6	3	1-5/16" J-Hook assembled to Angle Bracket Assembly - 3/8" mounting hole	40
CAT21VF14	4	1-5/16" J-Hook assembled to C purlin bracket - 1/16" thru 1/4" vertical flange	40
CAT21912SM	5	1-5/16" J-Hook assembled to hammer-on 1/2" thru 3/4" flange - side mount	40
CAT21912	6	1-5/16" J-Hook assembled to hammer-on 1/2" thru 3/4" flange - bottom mount rotates 360°	20
CAT2124SM	5	1-5/16" J-Hook assembled to hammer-on 1/8" thru 1/4" flange - side mount	40
CAT2124	6	1-5/16" J-Hook assembled to hammer-on 1/8" thru 1/4" flange - bottom mount rotates 360°	40
CAT2158SM	5	1-5/16" J-Hook assembled to hammer-on 5/16" thru 1/2" flange - side mount	40
CAT2158	6	1-5/16" J-Hook assembled to hammer-on 5/16" thru 1/2" flange - bottom mount rotates 360°	40
CAT21BC	7	1-5/16" J-Hook assembled to screw-on bracket - 1/8" thru 1/2" flange	40
CAT21BC200	8	1-5/16" J-Hook assembled to screw-on bracket - 1/8" thru 5/8" flange	40
CAT21BC200B	9	1-5/16" J-Hook assembled to screw-on bracket - 1/8" thru 5/8" flange - rotates 360°	40
CAT21BCB	7	1-5/16" J-Hook assembled to screw-on bracket 1/8" thru 1/2" flange - rotates 360°	40
CAT21CD1B	10	1-5/16" J-Hook assembled to under floor support to pedestal	40
CAT21AF14	11	1-5/16" J-Hook assembled to Z purlin bracket - 1/16" thru 1/4" Z purlin	40
CAT21ESC	12	Snap-in 1 5/16" Diameter J-Hook	60



Many ERICO® products are UL Listed.  
Please contact your ERICO representative for approval information.



Fig. #1



Fig. #2



Fig. #3



Fig. #4



Fig. #5



Fig. #6



Fig. #7



Fig. #8



Fig. #9



Fig. #10



Fig. #11



Fig. #12

See page 154  
for the complete  
CADDY® CABLECAT  
Capacity Guide

### Wide Base Cable Support Clips - 2" Diameter Loop



Part Number	Fig. #	Description	Standard Packaging Quantity
CAT324Z34	1	2" J-Hook assembled to 4Z34 - #12 thru 1/4" wire, plain or threaded rod and 1/8" thru 3/8" flange	40
CAT326Z34	1	2" J-Hook assembled to 6Z34 - 3/8" plain or threaded rod and 3/8" thru 7/16" flange	40
CAT32AB	2	2" J-Hook assembled to angle bracket - 1/4" mounting hole	40
CAT32AFAB3	3	2" J-Hook assembled to Angle Bracket Assembly - 3/16" mounting hole	40
CAT32AFAB4	3	2" J-Hook assembled to Angle Bracket Assembly - 1/4" mounting hole	40
CAT32AFAB6	3	2" J-Hook assembled to Angle Bracket Assembly - 3/8" mounting hole	40
CAT32VF14	4	2" J-Hook assembled to C purlin bracket - 1/16" thru 1/4" vertical flange	40
CAT32912SM	5	2" J-Hook assembled to hammer-on 1/2" thru 3/4" flange - side mount	40
CAT32912	6	2" J-Hook assembled to hammer-on 1/2" thru 3/4" flange - bottom mount rotates 360°	20
CAT3224SM	5	2" J-Hook assembled to hammer-on 1/8" thru 1/4" flange - side mount	40
CAT3224	6	2" J-Hook assembled to hammer-on 1/8" thru 1/4" flange - bottom mount rotates 360°	20
CAT3258SM	5	2" J-Hook assembled to hammer-on 5/16" thru 1/2" flange - side mount	40
CAT3258	6	2" J-Hook assembled to hammer-on 5/16" thru 1/2" flange - bottom mount rotates 360°	20
CAT32BC	7	2" J-Hook assembled to screw-on bracket - 1/8" thru 1/2" flange	40
CAT32BC200	8	2" J-Hook assembled to screw-on bracket - 1/8" thru 5/8" flange	20
CAT32BC200B	9	2" J-Hook assembled to screw-on bracket - 1/8" thru 5/8" flange - rotates 360°	20
CAT32BCB	7	2" J-Hook assembled to screw-on bracket 1/8" thru 1/2" flange - rotates 360°	20
CAT32CD1B	10	2" J-Hook assembled to under floor support to pedestal	20
CAT32AF14	11	2" J-Hook assembled to Z purlin bracket - 1/16" thru 1/4" Z purlin	40
CAT32ESC	12	Snap-in 2" Diameter J-Hook	40



Many ERICO® products are UL Listed.  
Please contact your ERICO representative for approval information.



Fig. #1



Fig. #2



Fig. #3



Fig. #4



Fig. #5



Fig. #6



Fig. #7



Fig. #8



Fig. #9



Fig. #10



Fig. #11



Fig. #12

See page 154  
for the complete  
CADDY® CABLECAT  
Capacity Guide

## CADDY® CABLECAT

Patent Number: 5,740,994

Wide Base Cable Support Clips -  
4" Diameter Loop



Part Number	Fig. #	Description	Standard Packaging Quantity
CAT64AFAB3	1	4" J-Hook assembled to Angle Bracket Assembly - 3/16" mounting hole	25
CAT64AFAB4	1	4" J-Hook assembled to Angle Bracket Assembly - 1/4" mounting hole	25
CAT64AFAB6	1	4" J-Hook assembled to Angle Bracket Assembly - 3/8" mounting hole	25
CAT64VF14	2	4" J-Hook assembled to C purlin bracket - 1/16" thru 1/4" vertical flange	25
CAT64912SM	3	4" J-Hook assembled to hammer-on 1/2" thru 3/4" flange - side mount	25
CAT64912	4	4" J-Hook assembled to hammer-on 1/2" thru 3/4" flange - bottom mount rotates 360°	25
CAT6424SM	3	4" J-Hook assembled to hammer-on 1/8" thru 1/4" flange - side mount	25
CAT6424	4	4" J-Hook assembled to hammer-on 1/8" thru 1/4" flange - bottom mount rotates 360°	25
CAT6458SM	3	4" J-Hook assembled to hammer-on 5/16" thru 1/2" flange - side mount	25
CAT6458	4	4" J-Hook assembled to hammer-on 5/16" thru 1/2" flange - bottom mount rotates 360°	25
CAT64BC	5	4" J-Hook assembled to screw-on bracket - 1/8" thru 1/2" flange	25
CAT64BC200	6	4" J-Hook assembled to screw-on bracket - 1/8" thru 5/8" flange	25
CAT64BC200B	7	4" J-Hook assembled to screw-on bracket - 1/8" thru 5/8" flange - rotates 360°	25
CAT64BCB	5	4" J-Hook assembled to screw-on bracket 1/8" thru 1/2" flange - rotates 360°	25
CAT64CD1B	8	4" J-Hook assembled to under floor support to pedestal	25
CAT64AF14	9	4" J-Hook assembled to Z purlin bracket - 1/16" thru 1/4" Z purlin	25



Many ERICO® products are UL Listed.  
Please contact your ERICO representative for approval information.



Fig. #1



Fig. #2



Fig. #3



Fig. #4



Fig. #5



Fig. #6



Fig. #7



Fig. #8



Fig. #9

See page 154  
for the complete  
CADDY® CABLECAT  
Capacity Guide

## CADDY® CABLECAT Pulley

### Features

- CAT32PLR accepts up to 20 four-pair cables
- Complies with the TIA<sup>SM</sup> standard requirement by minimizing the pull force on the cable
- Frees up the “second man” on cable pulling
- Kit includes spring-loaded J-hook, pin, wheel and retainer, link, and beam clamp
- Maintains proper bend radius and protects cable during the installation
- When the job is complete, the pulley and pin assembly can be removed leaving the J-hook as a cable support
- CAT64PLR accepts up to 40 four-pair cables
- The CAT32PLR pulley components can be used on original design CAT32 J-hook
- The CAT64PLR pulley components can be used on original design CAT64 J-hook



Part Number	Description	Standard Packaging Quantity
CAT32PLR	Pulley kit - CAT32 2" spring-loaded J-hook, pin, wheel and retainer, link and beam clamp	10
CAT64PLR	Pulley kit - CAT64 4" spring-loaded J-hook, pin, wheel and retainer, link and beam clamp	2





## CADDY® CABLECAT

### Vertical Backbone Cable Support

#### Features

- Makes vertical cable pulling easier - locking mechanism opens during pull and re-engages when cable is released
- Accepts wide range of cable sizes: (75) 4-pair UTP CAT5E, (47) CAT6, (10) 25-pair UTP, (1) each 100-pair through 600-pair.
- Available as wall-mount (#CAT600WM) or strut-mount (#CAT600R)\*
- Strut-mount includes pre-riveted assembly that twist-locks into the strut
- Rounded edges help prevent cable damage
- Valuable space savings within telecomm closets
- More versatile allowing future additions of cable runs
- Reduces installation time
- Allows cable installation to start at the bottom floor
- Galvanized finish for corrosion protection



Fig. #1



Fig. #2



Part Number	Fig. #	Description	Standard Packaging Quantity
CAT600R	1	Vertical Cable Support - Strut mount	2
CAT600WM	2	Vertical Cable Support - Wall mount	2
CAT600RKIT	1	Vertical Cable Support - Strut mount kit with (1) 18" precut slotted strut & (4) CAT600R	1

See page 154  
for the complete  
CADDY® CABLECAT  
Capacity Guide

## Adjustable Cable Support



### Features

- Up to 425 4-pair UTP or 2-strand fiber optic cable, or 265 CAT6 - 4" or 6" dia. loop
- Provides proper support of Category 5e, Category 6, fiber optic and innerduct
- Multiple sizes and designs available to attach to a variety of structures
- Cost effective alternative to expensive cable tray
- cULus® listed and complies with NEC® and TIA<sup>SM</sup> requirements for structured cabling systems
- Suitable for air handling spaces (plenum)

Part Number	Fig. #	Description	Standard Packaging Quantity
<b>Adjustable Cable Support</b>			
CAT425	1	Adj. Cable Support for use with 1/4" Threaded rod or horizontal surface	10
CAT425A6	2	Adj. Cable Support with 3/8" Threaded rod or horizontal surface	10
CAT425WM	3	Adj. Cable Support with Wall mount - vertical surface	10
<b>Beam Clamp</b>			
CAT425BC	4	Adj. Cable Support with Screw-on 1/8" - 1/2" flange (rotates 360°)	10
CAT425BC200	5	Adj. Cable Support with Screw-on 1/8" - 5/8" flange (rotates 360°)	10
<b>Hammer on Flange Clip</b>			
CAT42524SM	6	Adj. Cable Support with Hammer-on 1/8" - 1/4" flange	10
CAT42558SM	6	Adj. Cable Support with Hammer-on 5/16" - 1/2" flange	10
CAT425912SM	6	Adj. Cable Support with Hammer-on 9/16" - 3/4" flange	10
<b>Purlin</b>			
CAT425AF14	7	Adj. Cable Support with Hammer-on 1/16" - 1/4" Z purlin	10
CAT425VF14	8	Adj. Cable Support with Hammer-on 1/16" - 1/4" vertical flange	10
CAT425WMCD1B	9	Adj. Cable Support with Under floor pedestal	10





Fig. #1



Fig. #2



Fig. #3



Fig. #4



Fig. #5



Fig. #6



Fig. #7



Fig. #8



Fig. #9

See page 154  
for the complete  
CADDY® CABLECAT  
Capacity Guide

## CADDY® CAT CM

### Features

- Specially designed U-Hooks and double J-Hooks have large- diameter, rounded support surfaces/edges to avoid over-bending and kinking of cables
- Cable support system offering unprecedented installation flexibility
- Compliant with NEC® and ANSI®/TIA<sup>SM</sup> structured cabling systems standards
- Hooks are cULus® listed
- Convenient pathway for wires and cables
- Rod-Mounted allows for field assembly onto All-Thread Rod
- Cantilever-Mounted allows U-hooks to be mounted with brackets to walls and columns



Part Number	Fig. #	Description	Standard Packaging Quantity
CAT100CM	1	Double J-Hook	20
CAT200CM*	2	U-Hook 200 mm/8" with T-nut	10
CAT200CMLN	2	U-Hook 200 mm/8" less nut	10
CAT300CM*	2	U-Hook 300 mm/12" with T-nut	10
CAT300CMLN	2	U-Hook 300 mm/12" less nut	10
CATRL200CM	3	Roller 200 mm/8" (incl. rod & nuts)	10
CATRL300CM	3	Roller 300 mm/12" (incl. rod & nuts)	10
CATRT200CM	4	Wire Retainer 200 mm/8"	50
CATRT300CM	4	Wire Retainer 300 mm/12"	50
CATTBCM	5	Protection Tube	30
CATWMCM	6	Wall Bracket	10

\*Quick-Attach T-nut for HALFSLOT Strut

CABLE	CAT100CM ON ROD	CAT200CMLN ON ROD OR CANTILEVER	CAT300CMLN ON ROD OR CANTILEVER
4-pair UTP, Cat 5/5e	80	500	750
4-pair UTP, Cat 6	50	315	470
4-pair ScTP/FTP	40	250	375
4-pair STP	26	170	250
Area (sq. in.)	2 x 1.58	21.00	32.00





Fig. #1



Fig. #2



Fig. #3



Fig. #4



Fig. #5



Fig. #6

See page 154  
for the complete  
CADDY® CABLECAT  
Capacity Guide

## Multi-Purpose Clip

### Features

- Requires only a hammer to install
- Accommodates any beam flange from 1/8" to 1/2" thickness
- Accommodates standard 1/4-20 or #10-24 threaded bridle rings, standard drive rings as well as unthreaded bridle rings
- Supports drive rings or bridle rings from flange



Fig. #1

Part Number	Fig. #	Description	Standard Packaging Quantity
2FMP28	1	Multi-purpose clip that accommodates beam flange from 1/8" to 1/2"	100

**Note:** Drive rings not available from ERICO®



## Cable Gripper

### Features

- Attaches to existing holes in metal studs without tools or with Metal Stud Punch (MSP20)
- Delivers compliance with: NEC® 300.4(d), CEC 12-510 and 12-516
- Installs easily to metal and wood studs
- Provides secure installation of multiple cables with unique locking/unlocking system
- Staples, nails or screws to wood stud
- Supports four NMC or eight 4-pair UTP, Category 5 and higher (electrical and datacomm cannot be combined)



Patent Number:  
5,626,316



Part Number	Description	Bag Qty
CG4	Cable Gripper cable support	100

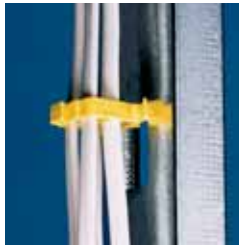

Refer to part number  
MSP20 for the Metal  
Stud Punch

## Plain, Threaded And Wood Screw Bridle Rings

### Features

- When combined with other CADDY® Fasteners, Bridle Rings can be located on:
- "C" Purlins – VF144TI.
- "Z" Purlins – 1224TI or AF144TI.
- Acoustical T-Grid – ATS4I or ATA4I.
- Beam Flanges up to 3/4" – 2FMP28, BC, BC200, M912.
- Concrete – 4TIB.
- Drop Wire – 4Z34 - 6Z34.



Fig. #1

Part Number	Fig. #	Description	Standard Packaging Quantity
2BR8	1	Bridle ring 1/2" dia. #8 wire	100
2BR12	1	Bridle ring 3/4" dia. #8 wire	100
2BR20	1	Bridle ring 1-1/4" dia. #8 wire	100
2BR32	1	Bridle ring 2" dia. #8 wire	100
2BRT8	2	Bridle ring 1/2" dia. 10-24 threaded	100
2BRT12	2	Bridle ring 3/4" dia 10-24 threaded	100
2BRT20	2	Bridle ring 1-1/4" dia. 10-24 threaded	100
2BRT32	2	Bridle ring 2" dia. 10-24 threaded	100
4BRT20	2	Bridle Ring 1-1/4" dia. 1/4-20 threaded	100
4BRT32	2	Bridle Ring 2" dia. 1/4-20 threaded	100
4BRT64	2	Bridle Ring 4" dia. 1/4-20 threaded	50
4BRT20WS	3	Bridle Ring 1-1/4" dia. #14 wood screw thread	100
4BRT32WS	3	Bridle Ring 2" dia. #14 wood screw thread	100

**Notes:** Bridle Rings not recommended for high performance cables, see CADDY® CABLECAT series.



Fig. #2



Fig. #3





## CADDY® CAT TRAX Continuous Cable Support System

### Features

- Sold as 25' rolls in convenient, easy-to-carry "kit" cartons
- Provides 32 square inches of cable containment area
- Attaches to any main or sub structure when used in concert with other CADDY® Fasteners
- Capacity exceeds a comparable 2" x 12" tray
- Compliant with NEC® and ANSI®/TIA<sup>SM</sup> structured cabling systems standards
- Convenient "snap-together" kits
- Hangers are UL® Listed for 200 lbs. spaced 4 to 5 feet apart; mesh is suitable for internal air handling spaces (plenum)
- Lightweight and flexible for easy installation
- Rod and structure attachments sold separately



Fig. #1



Fig. #2

Part Number	Fig. #	Description	Includes
CATTRAX25	1	CADDY CAT TRAX Continuous Cable Support Kit	(10) plastic splice clips (15) spring steel bracket clips (5) steel retaining clips (5) steel support brackets 25 ft. roll flexible mesh
CT128TRK	2	CADDY CAT TRAX Transition Kit	(30) plastic splice clips (5) steel retaining straps (5) wire transition pieces

Standard Packaging Quantity: 1



## CADDY® Mille-Tie™

### Features

- Suitable for heavy duty applications
- Maintains cable properties and conductor configuration
- Protects cable from crimping with "Intelligent Grip Technology"
- Cushions vibration
- No sharp edges
- One size fits all
- Reusable



Fig. #1

Part Number	Fig. #	Description	Standard Packaging Quantity
CATMTLS	1	Yellow CADDY Mille-Tie (Low Smoke - Zero Halogen)	1,000
CATMTP	2	Red CADDY Mille-Tie (suitable for air-handling spaces)	1,000
CATMTH	3	CADDY Mille-Tie Heavy Duty (Black)	100



Fig. #2



Fig. #3

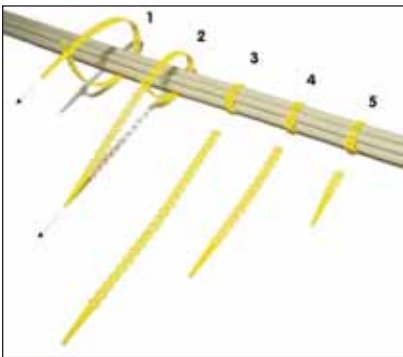

Mille-Tie is a trademark of Millepede International, Ltd.

## CADDY® CAT CR50 Cable Retainer



### Features

- Allows for horizontal and vertical change of direction
- Complies with the NEC®, the CEC and TIA<sup>SM</sup> standards
- Installs easily\works with CAT 5e and higher, fiber optic and coaxial cable
- Residential Application
- Suitable for air-handling spaces (plenum rating)



Part Number	Description	Standard Packaging Quantity
CATCR50	Cable Retainer 50 mm, 2" dia.	25



See page 154  
for the complete  
CADDY® CABLECAT  
Capacity Guide

## Camera, alarm and speaker hanging support solutions

### Features

- Reduces installation time
- Securely fastens cameras to various building structures
- Complies with codes and best practices



Fig. #1

Part Number	Fig. #	Description	Standard Packaging Quantity
SCMKB	1	Security Camera Mounting Kit - Beam	20
SCMKC	2	Security Camera Mounting Kit - Between T-grid	20
SCMKT	3	Security Camera Mounting Kit - T-grid	20
SCMKW	4	Security Camera Mounting Kit - Wall Mount	20



Fig. #2



Fig. #3



Fig. #4



## CADDY® LINIAN Clip

### Features

- After the hole is drilled, no tools are required for installation
- Corrosion-resistant coating
- Easily fixes fire-resistant cables to brickwork, concrete, masonry, wood studs and wood beams
- Independently tested to resist tensile loads of up to 24 lbs
- Installs up to 70% faster than saddle clips



Fig. #1

Part Number	Fig. #	Description	Standard Packaging Quantity
LI1	1	Coax, control & alarm cable; Coax, speaker wire, control & alarm cable	100
LI2	1	Coax, control & alarm cable; Coax, speaker wire, control & alarm cable	100



## Low Voltage Mounting Bracket For New Construction

### Features

- Provides a bracket for mounting low voltage Class 2 communication outlets
- Reduces bulges in the dry wall caused by plaster rings
- May be installed to the front or the side of the metal or wood stud
- Side support provides for a rigid installation
- Attaches with self-tapping screws or nails
- Works with 1/2" and 5/8" dry wall
- Works with wood or metal studs



Fig. #1

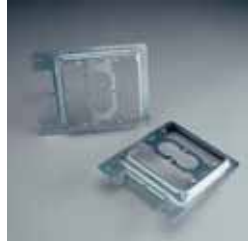

Fig. #2

**Notes:** No Load Rating - Positioning Only

Part Number	Fig. #	Description	Standard Packaging Quantity
MP1S	1	Single gang plate mounting bracket for new work	25
MP2S	2	Double gang plate mounting bracket for new work	25



## Mounting Plate Brackets (Metallic)

### Screw-On Support

#### Features

- Provides positive support with locking screws
- Mounts any standard low voltage device in 1/2" through 1 1/4" walls
- Makes wire "fishing" easier
- Install with a drywall saw and screwdriver
- Eliminates the need for an electrical box when installing low voltage Class 2 wiring



Fig. #1

**Notes:** For low voltage Class 2 use only.

Part Number	Fig. #	Description	Standard Packaging Quantity
MP1	1	Single gang Mounting Plate Brackets (no screws included)	100
MPLS	2	Single gang Mounting Plate Brackets screws to drywall (screws included)	100
MPLS2	3	Double gang Mounting Plate Brackets screws to drywall (screws included)	100



Fig. #2



Fig. #3

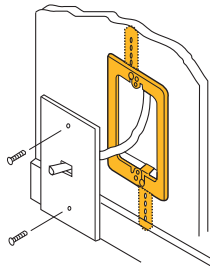

## Mounting Plate Brackets (Non-Metallic)

### Features

- No sharp metal edges with plastic design
- Fast, easy way to install
- No installation tools required to secure bracket in the drywall opening
- Serrated interlocking system secures tightly
- Template points on brackets help eliminate multiple measurement markings during installation
- Recessed design helps assure flush mount of device
- Only CADDY® provides the industry with the widest application range 1/4" to 1 1/4" wall thickness
- Available in single gang, double gang and a unique 3-4 gang sizes
- Eliminates the need for electrical boxes on low voltage class 2 applications



Fig. #1

**Notes:** For low voltage Class 2 use only.  
No Load Rating - Positioning Only

Part Number	Fig. #	Description	Standard Packaging Quantity
MP1P	1	Non-Metallic Single gang mounting plate	100
MPAL2	2	Non-Metallic double gang mounting plate	100
MP34P	3	Non-Metallic 3 or 4 gang mounting plate	2



Fig. #2



Fig. #3





## Metal Stud Punch And Easy Snap Grommet

### Features

- Cushioned handles mean less operator fatigue and more comfortable handling
- Tool design with offset handles allows punch to work in confined locations and near perpendicular walls
- Lightweight punch makes accurate location of holes easier
- Hardened steel components keep tool sharper longer – less replacement
- Punches up to 20 gauge sheet metal
- Plastic grommets snap easily into 1-11/32" hole



Fig. #1



Part Number	Fig. #	Description	Standard Packaging Quantity
MSP20	1	Metal Stud Punch	1

### Features

- Snap one grommet into standard 1-11/32" field punched hole, OR snap tight two together into any shape factory punched hole
- Provides 360° protection for cable and makes cable pulls easier



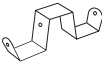













Fig. #2

Part Number	Fig. #	Description	Standard Packaging Quantity
ESG1	2	Metal Stud Grommet	100
ESG1M	2	Metal Stud Grommet	1,000
ESGP	3	Metal Stud Anti-Rattle Grommet	100
ESGPM	3	Metal Stud Anti-Rattle Grommet	1,000



Fig. #3

CADDY® CABLECAT Capacity Guide			
Area (sq. in.)	Capacity (4-pair)		Part Number
	Cat. 5e	Cat. 6	
0.60	16	10	CAT12 
2.16	50	32	CAT21 
3.17	80	50	CAT32 
2 x 1.58	80	50	CAT100CM 
15.28	300	185	CAT64 
20.43	425	265	CAT425 
21.00	500	315	CAT200CMLN 
32.00	750	470	CAT300CMLN 
32.00	750	470	CATTRAX25 
3.14	75	47	CAT600 
1.07	20	15	CAT16HP 
3.97	90	60	CAT32HP 
9.26	200	150	CAT48HP 
15.48	330	220	CAT64HP 
2.67	50	36	CATCR50 



# Acoustical/Ceiling/Partitions



# Acoustical/Ceiling/Partitions

## Seismic Fixture Clamp

### Features

- Cost effective
- Reusable
- Secures fluorescent light fixtures to the ceiling frame members
- Requires no additional chains, cables or slack wires attached to the fixture
- Helps strengthen integrity of the T-Bar system
- Holds in place against the force of standard fire-hose pressure
- Meets U.S. building code and electrical code specifications
- Also satisfies NEC® 410.16(C) positive attachment for secure fastening of luminaires (fixtures) complying with Acceptance Criteria 184



Fig. #1

Part Number	Fig. #	Description	Standard Packaging Quantity
SFCLT	1	Seismic Fixture Lighting Clamp (set of 4) for one standard tapered 2' x 4' light fixture	100
SFCLTCF	2	Seismic Fixture Lighting Clamp (set of 2) for one 2' x 2' light fixture. In addition, a set of CADDY® SFCLT is required	100
SFCLTCFS	3	Seismic Fixture Lighting Clamp (set of 2) for reinforcement of T-Bar main runner/cross runner connections	100
SFCLTE	2	Seismic Fixture Lighting Clamp (set of 2) for two standard tapered 2' x 4' light fixtures end-to-end. In addition, a set of CADDY® SFCLT is required	50
SFCLTS	2	Seismic Fixture Lighting Clamp (set of 2) for two standard tapered 2' x 4' light fixtures side-by-side. In addition, a set of CADDY SFCLT is required	50



Fig. #2



Fig. #3



SFC required at each corner

**Note:** The Seismic Fixture Clamp has been tested for compliance to the UBC, NEC, NBC, and CEC as well as approved and listed with:

- Warnock Hersey (Listed)
- ETL (Listed)
- Certified to CSA C22.2 No. 9.0-96 Component Only
- ID: Seismic Fixture Clamp



ICBO standards are a copyright of the International Code Council.  
ICC is a registered trademark of the International Code Council.  
Warnock Hersey & ETL are listing marks of Intertek Testing Services, NA.

# Acoustical/Ceiling/Partitions

## Lay In And Troffer Light Fixture Support Clips

### Features

- Complies with The National Electrical Code, Article 410.16 Means of Support
- Gives a positive method of securing troffers and lay-ins
- Fits round or rectangular head tee bar
- No tools required for installation
- 4 clips per fixture required per UL listing
- 515 For straight lip fixtures
- 515A For straight or upturned lip fixtures



Fig. #1

**Works On  
New Taller  
T-Grid!**



Part Number	Fig. #	Description	Standard Packaging Quantity
515	1	Straight lip fixtures	100
515A	2	Upturned or straight lip fixtures	100



Fig. #2

## TGE Clip T-Grid Splicing Clip

### Features

- Replaces pop riveting
- No need to cut and bend "T"
- Can be used to splice across "T" into the main "T"
- "T" to edge angle

Part Number	Description	Standard Packaging Quantity
TGE	Attaches tee to edge trim	100



# Acoustical/Ceiling/Partitions

## Electrical Component Supports

### Features

- Provides a method of supporting conduit and outlet boxes above acoustical tee bar
- Available for both horizontal and vertical support
- Clips are available with 1/4-20 thread impression or plain hole
- Riveted assemblies accommodate MC/AC to 1" conduit
- No installation tools required for basic clip
- Additional support required per NEC 300.11



Fig. #3

Part Number	Fig. #	Side or Top Mounted	Description	Standard Packaging Quantity
12PATS	1	Side	for 3/4" conduit	100
16PATS	1	Side	for 1" conduit	100
8PATS	1	Side	to 1/2" conduit	100
12PATA	2	Top	for 3/4" conduit	100
16PATA	2	Top	for 1" conduit	100
8PATA	2	Top	for 1/2" conduit	100
ATA4I	3	Top	1/4-20 thread impression	100
ATS4I	4	Side	1/4-20 thread impression	100
16MATS	5	Side	for 1" conduit	100
6MATS	5	Side	for MC/AC cable	100
812MATS	5	Side	for 1/2" to 3/4" conduit	100
16MATA	6	Top	for 1" conduit	100
6MATA	6	Top	for MC/AC cable	100
812MATA	6	Top	for 1/2" - 3/4" conduit	100

**Notes:** No Load Rating - Positioning Only; Eliminates need for offset bending conduit; Additional support required per NEC 300.11



Fig. #1



Fig. #2



Fig. #4



Fig. #5



Fig. #6



# Acoustical/Ceiling/Partitions

## Independent Support Clips

### Features

- Provides a means of independent support of fixtures
- No tools required for installation
- Includes mounting hardware



Fig. #1

Static Load: 65 lbs.

Part Number	Fig. #	Grid Size (in)	Stud Length (in)	Standard Packaging Quantity
<b>Stud: 1/4-20</b>				
IDS	1	15/16	5/8	100
IDS15	1	15/16	1 1/2	100
IDS2	1	15/16	2	100
IDS9*	1	9/16	5/8	100
IDS95 <sup>†</sup>	2	9/16 x 5/16	5/8	100
<b>Stud: 8-32</b>				
IDST <sup>†</sup>	3	15/16	9/16	100
IDS9T <sup>†</sup>	3	9/16	9/16	100
IDS95T <sup>†</sup>	2	9/16 x 5/16	9/16	100

\*For Ultra Line 3500, AWW Ultra Line 3600 (a trademark product of Chicago Metallics Corp.)

<sup>†</sup>For Fineline and Fineline 1/8" Grids (a trademark product of USG Interiors®, Inc.)

<sup>†</sup>Uses identical nuts as figure 3



Fig. #2



Fig. #3



Optional barrel nut:  
order by adding -WB  
suffix to part number  
(IDSTWB)

# Acoustical/Ceiling/Partitions

## Snap On Fixture/ Box Hanger



Fig. #1

### Features

- Snaps easily onto tee bar
- Hanger comes complete with box mounting clip and 1/4-20 screw
- Supports from acoustical tee bar as well as main structure with the use of a drop wire
- Dual height feature permits 1-1/2" deep electrical box to be mounted flush with tile or off-set 3/4" for plaster ring
- 512A is height adjustable up to 8" allowing you to install double deep boxes, speaker cases and emergency light fixtures above acoustical tee
- Not permitted for paddle fans

Part Number	Fig. #	Description	Standard Packaging Quantity
512	1	Electrical box hanger - 24" span	50
51212	1	Electrical box hanger - 12" span	50
51220	1	Electrical box hanger - 20" span	50
51230	1	Electrical box hanger - 30" span	50
512A	2	8" height adjustable - 24" span	50
512ATC*	2	8" height adjustable - 24" span	50
512TC*	1	Electrical box hanger - 24" span	50
CHB	3	Box mounting clip	100
CHBTC*	3	Box mounting clip	100
S102438BP50*	-	10-24 1/2" Rnd Hd Robertson screw	50

\*For Canadian boxes

**Notes:** Not to exceed 20 lbs. without independent wire support to CHB. CHB can be purchased separately when more than one box is required. Screw furnished. One CHB mounting clip is included with each 512.



Fig. #2



Fig. #3





# Acoustical/Ceiling/Partitions

## T-Grid Box Hanger

### Features

- Quickly mounts a box to T-grid
- Now height adjustable for various electrical box depths
- Installs by hand
- Drop wire for independent support from clip and/or bar
- Screws easily to tee bar for added stability
- Multiple box installations
- Double deep box installations
- 512HDXT Extension Brackets
- Not permitted for paddle fans



Fig. #1

Patent Number: 5,619,263

Static Load: 50 lbs.

Part Number	Fig. #	Description	Standard Packaging Quantity
510HD	1	Box mounting clip can be purchased separately for multiple box requirements	100
510HDTC*	2	Box mounting clip can be purchased separately for multiple box requirements	100
512HD†	1	Heavy-duty electrical box hanger with box mounting clip – 24" span	25
512HDEEP†	1	Heavy-duty electrical box hanger with extension bracket – 3 5/8" height	25
512HDEEPTC*	1	Heavy-duty electrical box hanger with extension bracket – 3 5/8" height	25
512HDTC*	1	Heavy-duty electrical box hanger with box mounting clip – 24"	25
512HDXT†	3	Extension bracket 3 5/8" height (25 sets)	50

\*For Canadian boxes

†Tall grid compatible.

**Notes:** 512HD Series Standard bar mounts 2-1/8" box – break off tabs for 1-1/2" deep box. Mounts flush with face of tile.

512HDEEP Series with additional 512HDXT mounts 2-1/8" deep box with 1-1/2" extension ring.

One 510HD box mounting clip is included with each 512HD and 512HDEEP.



Fig. #2



Fig. #3



# Acoustical/Ceiling/Partitions

## Suspension Bar For Light Fixtures 517 Series

### Features

- Reduces installation time
- No tools required for installation
- End clips rotate for mounting horizontal or vertical base plates
- Position of fixture is adjustable, simply slide to location
- No center clips required
- Span adjustable 11" to 26"

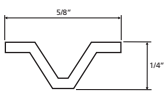
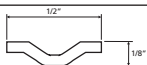
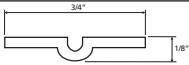

**Works On  
New Taller  
T-Grid!**

Part Number	Replacement Bar Type	Light Fixtures
517A	 to Standard 5/8" x 1/4"	CAPRI PR-751CX; CAPRI R-10C; CAPRI R-10X; CAPRI R-9X; HALO H17; JUNO AP; JUNO APT; JUNO IC; JUNO ICT; JUNO J; JUNO SC; JUNO TC; THOMAS RI-IC
517FCA		
517B	 to Narrow 1/2" x 1/8"	CAPRI HSG; HALO H7; LIGHTOLIER 711
517FCB		
517C	 to Wide 3/4" x 1/8"	MARCO; Progress P-7
517FCC		

**Notes:** Applicable to a wide variety of light fixtures.; Measure width of bar to find appropriate bar for fixture.; No Load Rating - Positioning Only; The 517 series bar replaces the fixture bar.

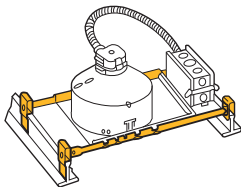

T-Grid Applications

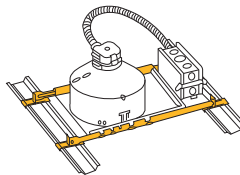

Hat Channel Applications

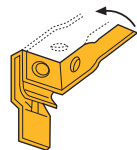

End clips rotate for mounting horizontal or vertical base plates



# Acoustical/Ceiling/Partitions

## Suspension Bars For Lightolier® Calculite® Series Fixtures



### Features

- Reduces installation time
- Only a screwdriver required
- Position of fixture is adjustable with span

**Note:** No Load Rating - Positioning Only

Part Number	Description	Standard Packaging Quantity (Set)
520	Suspension bars for Lightolier Calculite series fixtures	10

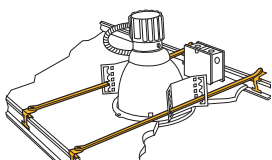

Lightolier and Calculite are registered trademarks of Lightolier, a GENLYTE Company.

## "Twist On" Track Light Clips

### Features

- Fast, easy installation
- No special tools required
- Will not damage T-bars
- Available in white finish
- Nut included – standard pal nut  
For brass hex nut add WB to part number (2G9WB)

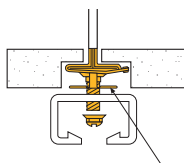

Static Load: 25 lbs

Spacer

Part Number	Description	Surface Finish	Stud Length (in)	Standard Packaging Quantity
2G9	For 9/16" tee	Silver	7/16	100
2G9S10	For 9/16" tee	Silver	5/8	100
4G8	For 15/16" tee	Silver	5/8	100
4G8S7	For 15/16" tee	Silver	7/16	100
4G8S7WH	For 15/16" tee	White	7/16	100
4G8WH	For 15/16" tee	White	5/8	100

# Acoustical/Ceiling/Partitions

## “Twist On” Fixture Support

### Features

- Supports electrical fixtures from acoustical tee bar 9/16", 15/16" or 1-1/2" wide
- 1/4-20 stud – 5/8", 1-1/2", 2" or 3" long
- Washer-wing nut (4WN) included
- No tools required for installation



Fig. #1

Part Number	Fig. #	Description	Static Load (lbs)	Stud Length (in)	Standard Packaging Quantity
4TGS*	1	For recess T-grid system	25	1/4	100
4G24	2	For 1 1/2" tee with 4WN	40	5/8	100
4G16H	3	For 15/16" tee	40	1	100
4G16	4	For 15/16" tee	50	5/8	100
4G1615	4	For 15/16" tee	50	1 1/2	100
4G162	4	For 15/16" tee	50	2	100
4G163	4	For 15/16" tee	50	3	100
4G9	4	For 9/16" tee	40	5/8	100

\*4TGS: To be used with studded Twist Clips



Fig. #2



Fig. #3



Fig. #4



# Acoustical/Ceiling/Partitions

## Lock-On Twist Clip

### Features

- Attaches easily to tee bar
- Doesn't harm acoustical tee
- Fits 15/16" tee bar
- Provides "positive lock" to position fastener
- 4WN washer wingbut included

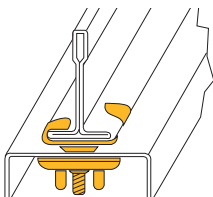

Fig. #1

Part Number	Fig. #	Description	Static Load	Standard Packaging Quantity
PT16	1	Lock-on twist clip for 15/16" tee, 3/4" stud	50	100
PT16FP	1	With felt pad	50	100
PT16SPCR	2	Plastic spacer for PT16	N/A	100



Fig. #2



## Conduit Clip

### Features

- Secure 1/2", 3/4", 1", 1-1/4" thin wall conduit to 1-1/2" lathers channel
- No tools required for installation



**Static Load:** 50 lbs

(When conduit hangs below lathers channel)

Part Number	Description
8D15L	1/2" EMT Conduit to 1-1/2" lathers channel
12D15L	3/4" EMT conduit to 1-1/2" lathers channel
16D15L	1" EMT conduit to 1-1/2" lathers channel
20D15L	1-1/4" EMT conduit to 1-1/2" lathers channel

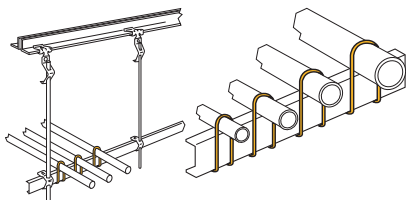

# Acoustical/Ceiling/Partitions

## Fluorescent Light Fixture Hanger

### Features

- Provides an easy method of supporting an industrial class fluorescent light fixture from S-Hooks and Jack Chain.
- Fits most fluorescent light fixtures.
- Reduces the need to modify Jack Chain for fixture installation.
- Requires no special tools for installation.



Fig. #1

Static Load: 50 lbs.

Part Number	Fig. #	Description	Standard Packaging Quantity
LFC	1	Side mount clip	100
LFC90	2	Top mount clip	100



Fig. #2



## Jack Chain And S-Hooks

Static Load: 29 lbs.

Part Number	Description	Standard Packaging Quantity
770	#12 Jack Chain 100 ft	1
771	#11 S-Hooks	50



# Acoustical/Ceiling/Partitions

## Independent Electrical Drop Wire/Rod Securing Clip



Fig. #1

### Features

- Helps prevent sway of dedicated electrical drop wire/rod
- Will not affect ceiling grid systems negatively
- No tools required for installation. Forgiving design doesn't require exact cutting of rod/wire
- Painted yellow for easy identification by the inspector

Part Number	Fig. #	Description	Standard Packaging Quantity
EC311	1	Electrical drop wire securing clip #12 thru #8 wire	100
EC3114Z34	2	#12 wire thru 1/4" threaded rod	100
EC3116Z34	2	3/8" threaded rod	100
EC311P	3	Plastic electrical drop wire securing clip #12 thru #8 wire	100

**Notes:** Consult local authority for application approval.  
Refer to NEC 300.11



Fig. #2



Fig. #3

**Works On  
New Taller  
T-Grid!**



# Acoustical/Ceiling/Partitions

## Adjustable Box And Conduit Support (DFN)



Fig. #1

### Features

- Supports boxes and conduit above acoustical T-bar with adjustments from 4-1/4" through 7-1/4"
- Allows attachment of conduit clips with thread impressions at required height
- No tools required for installation

No Load Rating - Positioning Only

Part Number	Fig. #	Description	Conduit Size (in)	Standard Packaging Quantity
528	1	Adjustable box and conduit support (DFN)	-	50
52812P	2	Tee-bar rivet to hanger assembly 3/4" EMT	For 3/4 EMT	25
52816P	2	Tee-bar rivet to hanger assembly 1" EMT	For 1 EMT	25
5288P	2	Tee-bar rivet to hanger assembly 1/2" EMT	For 1/2 EMT	25

**Note:** Comes with P-series with THD impression screw assembled to top hole location (adjustable).



Fig. #2

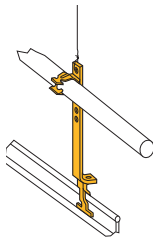

Additional support wire required per NEC 300.11





# Acoustical/Ceiling/Partitions

## Conduit/Box Support

### Features

- Provides a method for attaching above acoustical tee bars
- Provided with 1/4-20 screw for attachment to tee bar
- Has a 1/4-20 thread impression for direct attachment to an outlet box or conduit clips
- When used in combination with a conduit clip and outlet box, it provides exact alignment – eliminating an offset bend in the conduit



Part Number	Description	Standard Packaging Quantity
4ACS	Conduit/box support on T-grids	100

Works On  
New Taller  
T-Grid!

**Notes:** Consult local authority for application approval; Not to be used to hang Tee Grid

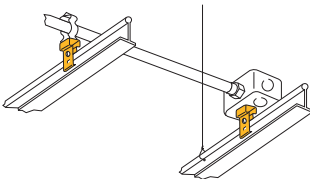

# Acoustical/Ceiling/Partitions

## Lathers Channel Hanger

- Attaches 1-1/2" lathers channel to #8 wire, 1/4" plain rod
- Attaches 2" lathers channel to 1/4" plain rod
- Available in both center and sidemount for 1/4" rod
- Provides pre-leveling of channel
- Will fit channel flange widths 7/16" thru 5/8"
- No tools required for installation



Fig. #1

Static Load: 160 lbs.

Part Number	Fig. #	Description	Standard Packaging Quantity
2B15LS	1	#8 Wire to 1-1/2" lathers channel side mount	100
4B15LS	1	1/4" Rod to 1-1/2" lathers channel side mount	100
4B2LS	1	1/4" Rod to 2" lathers channel side mount	100
4B15L	2	1/4" Rod to 1-1/2" lathers channel	100



Fig. #2

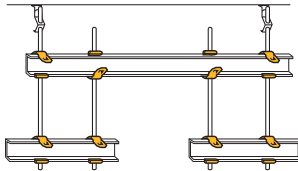

- Helps eliminate the major problem of cutouts for lighting layouts, ducts, obstructions and architectural changes
- Provides a method for attaching 1-1/2" channel to existing #8 wire, #9 wire, 3/16" or 1/4" plain rod, or 1/8" - 3/16" x 1" wide strap
- No tools required for installation



Fig. #3

Part Number	Fig. #	Description	Standard Packaging Quantity
HRL15A	3	Lathers Channel Hanger #9 and #8 wire- 3/16" and 1/4" plain rod; 1/8" and 3/16" thick strap (flange)	100

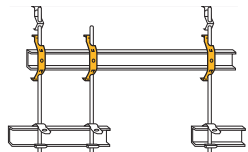

# Acoustical/Ceiling/Partitions

## Lathers to T-Grid Hanger Clip

### Features

- Allows 6" drop space providing area for light fixtures
- Fits 1-1/2" channel with flange widths from 1/2" to 5/8"
- Installs quickly and easily



Fig. #1

Part Number	Fig. #	Description	Standard Packaging Quantity
LTGH	1	Provides 6" space in supporting acoustical tee from 1-1/2" lathers channel	100



## Lathers Channel Box Mount

### Features

- Provides attachment of conduit and outlet boxes directly to lathers channel with 1/4-20 x 3/4" screw furnished
- Can be applied to the top or bottom flange of the channel
- Fits most lathers channel 3/4", 1-1/2" and 2". Maximum flange width 5/8"



Part Number	Description	Standard Packaging Quantity
4LCB	Lathers channel box mount	100

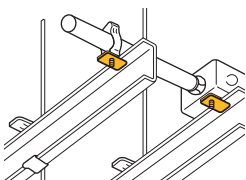

Eliminates offset bending conduit

# Acoustical/Ceiling/Partitions

## Support Box From Lathers Channel

### Features

- Provides a convenient method of supporting an electrical box from 3/4" thru 2" lathers channel
- "One piece/two piece" construction helps prevent dropping of loose parts
- Built-in thread impressions eliminate the need for nuts
- Multiple pre-punched holes allow for box height adjustability and screw and nut are provided



Part Number	Lathers Channel Size	Standard Packaging Quantity
LCSB12	3/4," 1," 1 1/2" or 2"	50

**Notes:** No Load Rating - Positioning Only

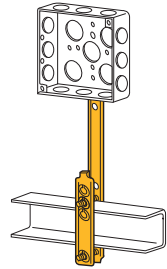

# Miscellaneous



# Miscellaneous

## Hangers

- Permits pre-assembly of wire and plain rod (#8, 1/4" and 3/8")

Part Number	Fig. #	Description	Static Load (lbs)	Standard Packaging Quantity
708	1	For #8 wire or 1/4" plain rod	160	100
6A	2	For 3/8" plain rod	160	100

- Permits wire or chain drops from concrete or wood

Part Number	Fig. #	Description	Static Load (lbs)	Standard Packaging Quantity
AB	3	Angle bracket w/ 1/4" hole	160	100
AO	4	Offset bracket w/ 1/4" hole	160	100

- Rod hanger available for 1-1/4" and 3/8" threaded rod with or without thread impression

Part Number	Fig. #	Description	Static Load (lbs)	Standard Packaging Quantity
6T	5	For 1/4" or 3/8" threaded rod nuts required	160	100
4TI	5	For 1/4" threaded rod with thread impression	160	100
6TI	5	For 3/8" threaded rod with thread impression	160	100



Fig. #1



Fig. #2



Fig. #3



Fig. #4



Fig. #5

## Pin Driven Angle Brackets

### Features

- Longer leg angle bracket for tool clearance
- Designed to fit a variety of pin drivers
- Improved for easier installation with pin drivers
- Pre-galvanized steel
- Pre-assembly options available for rod, wire, strap and cable applications



Part Number	Description	Working Load (lbs)	Standard Packaging Quantity
AFAB3	Angle bracket with 1/4" slotted hole and 3/16" mounting hole.	160	100
AFAB4	1/4" mounting hole (includes 1/4- 20 x 3/8" round head screw)	350	50
AFAB6	3/8" mounting hole (includes 1/4- 20 x 3/8" round head screw)	350	50

**Note:** Load limits apply to CADDY® Fasteners only. Pin must be evaluated separately.



## Strut Nuts

### Features

- Available with a 1/4-20 staked stud 5/8" long
- Eliminates nuts and bolts
- Fits standard 1 5/8" strut
- Requires only a screwdriver to install, adjust or remove
- The combination washer-wing nut (Part No. 4WN) can be used to attach box or fixture (Not included with strut clip)
- Available with a 1/4-20 thread impression

1 5/8" (41 mm) wide

Part Number	Fig. #	Description
MFA4I	1	1/4-20 thread impression

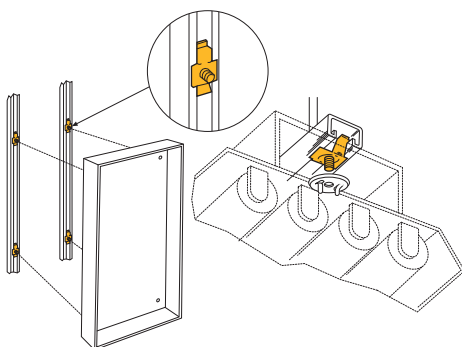

Fig. #1

Part Number	Fig. #	Description	Stud Length (in)
MFA625	2	1/4-20 x 5/8" stud	5/8



Fig. #2



# Miscellaneous

## Hammer on Flange Clip / Pipe Sleeve Positioner



### Features

- Requires only a hammer to install
- Will accommodate Schedule #40, #80 and smaller wall thickness
- Provides secure positioning of pipe sleeve for concrete pouring of wall and floor forms

**Notes:** No Load Rating - Positioning Only

Part Number	Sleeve Diameter (in)	Wall Thickness	Standard Packaging Quantity
740	2 to 6	Sch. 40 pipe	100

### Features

- Provides a "portable" 1/4" hole
- Fits most beams and bulb tees
- Installs with just a hammer



Part Number	Flange Thickness (in)	Standard Packaging Quantity
4H58	5/16 to 1/2	100

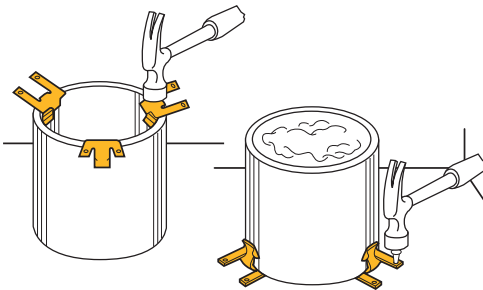



# Miscellaneous

## Signal Reference Grid Wire Clamp

### Features

- Provides a quick method to mechanically support a signal reference grid wire below computer room floors.
- One fastener will support #2 wire, #8 stranded (.146) to #4 stranded (.280).
- Fits post sizes 3/4" to 1" round or square.
- Slots in fastener grip wire to provide positive contact with post.
- Clamps grid wire directly to post allowing a low resistance connection across bare metal contacts.
- Installs easily with a screwdriver or nut driver.



Part Number	Wire Size Gauge	Post Size (in)	Standard Packaging Quantity
RGC	#2 Wire, #8 Solid (.146) thru #4 Stranded (.280)	3/4 to 1 round or square	100

## Metal Screws

- Minimizes drywall bulge.
- Self-drilling and tapping.

Patent Number: 5,740,994

Part Number	Fig. #	Description	Standard Packaging Quantity
SMS8	1	#8 x 1/2 low profile-self drilling and tapping screw	1,000



Fig. #1

**Notes:** Use to mount CADDY® Fasteners in all metal stud applications.

- For CADDY® CABLECAT Wide Base Cable Support.

Part Number	Fig. #	Description	Standard Packaging Quantity
S3575BP100	2	1/4- 20 x 3/8" round head screw	100
S3575DP100	2	1/4- 20 x 3/4" round head screw	100

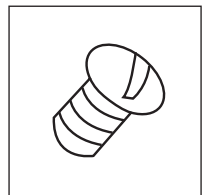

Fig. #2

# Miscellaneous

## HangerMate® Threaded Rod Anchoring System



### Features

- Easy installation of 3/8-16 or 1/4 -20 threaded rod
- Vertical- or side-mount applications
- Installs and taps steel, wood and concrete with drill

Part Number	Rod Size (in)	Description	Standard Packaging Quantity
<b>Concrete Applications – Vertical Mount (End-drilled Head)</b>			
HMZG365	1/4-20	5/16 X 2-1/4" HangerMate Anchor	50
HMZG730	3/8-16	5/16 X 2-1/4" HangerMate Anchor	50
<b>Steel Applications – Horizontal Mount (Cross-drilled Head)</b>			
HMZH455	3/8-16	1/4-20 X 1" HangerMate Anchor, #2 point (.060-.125 steel thickness)	50
HMZH475	3/8-16	1/4-20 X 1" HangerMate Anchor, #3 point (.060-.250 steel thickness)	50
HMZH476*	3/8-16	1/4-20 X 1" HangerMate Anchor with nut, #3 point (.060-.250 steel thickness)	50
<b>Steel Applications – Vertical Mount (End-drilled Head)</b>			
HMZG160	1/4-20	1/4-20 HangerMate Anchor, #3 point	50
HMZG471*	3/8-16	1/4-20 HangerMate Anchor, #3 point with nut	50
HMZG550	3/8-16	5/16-24 X 1-1/8 HangerMate Anchor, #3 point	50
<b>Wood Applications – Horizontal Mount (Cross-drilled Head)</b>			
HMZH665	3/8-16	5/16 X 2-1/4" HangerMate Anchor	50
<b>Wood Applications – Vertical Mount (End-drilled Head)</b>			
HMZG315	1/4-20	5/16 X 2-1/4" HangerMate Anchor	50
HMZG660	3/8-16	5/16 X 2-1/4" HangerMate Anchor	50
<b>Installation Tools</b>			
HMZE215	-	Vert Recessed Drive Socket	1
HMZE220	-	Concrete Recessed Drive Sleeve	1
HMZE240	-	Drill Bit Adapter Kit	1
HMZE340	-	ANSI 1/4" Tanged Drill Bit for Hammer Drills	1
HMZE350	-	ANSI 1/4" SDS Drill Bit for Rotary Hammer Drills	1

\*Nut required for light guage steel applications (16 GA or 0.060")



HangerMate is a registered trademark of Textron Inc.

# Reference

## Convenient Sizing Information

RIGID STEEL CONDUIT (Heavy Wall Conduit)				
Nominal Conduit Size	Outside Diameter	Nominal Inside Diameter	Minimum Wt. Per 100 Ft. With Couplings Attached	Weight Of Conduit & Conductors Per 100 Ft.
3/8"	0.675 in.	0.493 in.	51.5 lbs.	65.1 lbs.
1/2"	0.840 in.	0.632 in.	79.0 lbs.	101.1 lbs.
3/4"	1.050 in.	0.836 in.	105.0 lbs.	145.8 lbs.
1"	1.315 in.	1.063 in.	153.0 lbs.	219.3 lbs.
1 1/4"	1.660 in.	1.394 in.	201.0 lbs.	318.3 lbs.
1 1/2"	1.900 in.	1.624 in.	249.0 lbs.	408.8 lbs.
2"	2.375 in.	2.083 in.	332.0 lbs.	593.8 lbs.
2 1/2"	2.875 in.	2.489 in.	527.0 lbs.	901.0 lbs.
3"	3.500 in.	3.090 in.	682.6 lbs.	1259.0 lbs.
3 1/2"	4.000 in.	3.570 in.	831.0 lbs.	1604.0 lbs.
4"	4.500 in.	4.050 in.	972.3 lbs.	1967.0 lbs.
INTERMEDIATE METAL CONDUIT				
1/2"	0.815 in.	0.745 in.	60.0 lbs.	82.1 lbs.
3/4"	1.029 in.	0.954 in.	82.0 lbs.	122.8 lbs.
1"	1.290 in.	1.205 in.	116.0 lbs.	182.3 lbs.
1 1/4"	1.638 in.	1.553 in.	150.0 lbs.	267.3 lbs.
1 1/2"	1.883 in.	1.793 in.	182.0 lbs.	341.8 lbs.
2"	2.360 in.	2.266 in.	242.0 lbs.	503.8 lbs.
2 1/2"	2.857 in.	2.727 in.	401.0 lbs.	775.0 lbs.
3"	3.476 in.	3.346 in.	493.0 lbs.	1069.0 lbs.
3 1/2"	3.971 in.	3.841 in.	573.0 lbs.	1346.0 lbs.
4"	4.466 in.	4.336 in.	638.0 lbs.	1632.0 lbs.
ELECTRICAL METALLIC TUBING (EMT) – THIN WALL CONDUIT				
3/8"	0.577 in.	0.493 in.	23.0 lbs.	36.6 lbs.
1/2"	0.706 in.	0.622 in.	28.5 lbs.	50.6 lbs.
3/4"	0.922 in.	0.824 in.	43.5 lbs.	84.3 lbs.
1"	1.163 in.	1.049 in.	64.0 lbs.	130.3 lbs.
1 1/4"	1.510 in.	1.380 in.	95.0 lbs.	212.3 lbs.
1 1/2"	1.740 in.	1.610 in.	110.0 lbs.	269.8 lbs.
2"	2.197 in.	2.067 in.	140.0 lbs.	401.8 lbs.
2 1/2"	2.875 in.	2.731 in.	205.0 lbs.	579.0 lbs.
3"	3.500 in.	3.356 in.	250.0 lbs.	826.3 lbs.
3 1/2"	4.000 in.	3.834 in.	325.0 lbs.	1098.0 lbs.
4"	4.500 in.	4.334 in.	370.0 lbs.	1364.0 lbs.

Dimensions taken from ANSI™ C80.3-1977.

Conduit plus weight of heaviest conductor combination as specified by the National Electrical Code.

# Reference

## RIGID ALUMINUM CONDUIT

Nominal Conduit Size	Outside Diameter	Nominal Inside Diameter	Minimum Wt. Per 100 Ft. With Couplings Attached	Weight Of Conduit & Conductors Per 100 Ft.
1/2"	0.840 in.	0.632 in.	27.4 lbs.	49.5 lbs.
3/4"	1.050 in.	0.836 in.	36.4 lbs.	77.2 lbs.
1"	1.315 in.	1.063 in.	53.0 lbs.	119.3 lbs.
1 1/4"	1.660 in.	1.394 in.	69.6 lbs.	186.9 lbs.
1 1/2"	1.900 in.	1.624 in.	82.2 lbs.	242.0 lbs.
2"	2.375 in.	2.083 in.	115.7 lbs.	377.5 lbs.
2 1/2"	2.875 in.	2.489 in.	182.5 lbs.	556.5 lbs.
3"	3.500 in.	3.090 in.	238.9 lbs.	815.2 lbs.
3 1/2"	4.000 in.	3.570 in.	287.7 lbs.	1061.0 lbs.
4"	4.500 in.	4.050 in.	340.0 lbs.	1334.0 lbs.
5"	5.563 in.	5.073 in.	465.4 lbs.	2028.0 lbs.
6"	6.625 in.	6.093 in.	612.5 lbs.	2870.0 lbs.

Dimensions taken from ANSI C80.5-1977.

Conduit plus weight of heaviest conductor combination as specified by the National Electrical Code.

## SCHEDULE 40 PVC PLASTIC PIPE

Nominal Pipe Size	Outside Diameter	Wall Thickness	Weight Of Pipe	Weight Of Water
1/8"	.405 in.	.068 in.	.04 lbs./ft.	.02 lbs./ft.
1/4"	.540 in.	.088 in.	.07 lbs./ft.	.04 lbs./ft.
3/8"	.675 in.	.091 in.	.10 lbs./ft.	.08 lbs./ft.
1/2"	.840 in.	.109 in.	.15 lbs./ft.	.1 lbs./ft.
3/4"	1.050 in.	.113 in.	.2 lbs./ft.	.2 lbs./ft.
1"	1.315 in.	.133 in.	.3 lbs./ft.	.4 lbs./ft.
1 1/4"	1.660 in.	.140 in.	.4 lbs./ft.	.6 lbs./ft.
1 1/2"	1.900 in.	.145 in.	.5 lbs./ft.	.9 lbs./ft.
2"	2.375 in.	.154 in.	.6 lbs./ft.	1.4 lbs./ft.
2 1/2"	2.875 in.	.203 in.	1.0 lbs./ft.	2.1 lbs./ft.
3"	3.500 in.	.216 in.	1.3 lbs./ft.	3.2 lbs./ft.
3 1/2"	4.000 in.	.226 in.	1.6 lbs./ft.	4.3 lbs./ft.
4"	4.500 in.	.237 in.	1.9 lbs./ft.	5.5 lbs./ft.



# Reference

## ALL THREADED ROD (ATR)

Nominal Size and Thread	Root Area		Design Load (SF = 5)	
1/4" - 20"	0.027 in.2	0.174 cm2	240 lbs.	1.07 kN
5/16" - 18"	0.045 in.2	0.290 cm2	400 lbs.	1.78 kN
3/8" - 16"	0.068 in.2	0.438 cm2	610 lbs.	2.71 kN

Dimensions taken from ANSI™ B1.1-1982 Unified Inch Screw Threads.  
All threads are UNCR series.

Tabulated loads are based on an allowable tensile stress of 12000 psi (82.7 MPa) reduced by 25% resulting in 9000 psi (62 MPa). From ANSI®/MSS SP-58, Table 3.

## MC CABLE

AWG Size	<u>INSULATED GROUND</u>	<u>BARE GROUND</u>
	Nominal Outer Diameter in Inches	Nominal Outer Diameter in Inches
14-2 Solid	.450	.430
14-3 Solid	.480	.435
14-4 Solid	.510	.485
12-2 Solid	.495	.465
12-3 Solid	.530	.500
12-4 Solid	.565	.560
10-2 Solid	.560	.520
10-3 Solid	.600	.550
10-4 Solid	.645	.615
8-2 Strd.	.710	.675
8-3 Strd.	.770	.710
8-4 Strd.	.835	.770
6-2 Strd.	.795	.755
6-3 Strd.	.865	.800
6-4 Strd.	.945	.865
4-2 Strd.	.945	.895
4-3 Strd.	1.035	.945
4-4 Strd.	1.135	1.035
2-2 Strd.	1.075	1.015
2-3 Strd.	1.180	1.075
2-4 Strd.	1.295	1.180

ANSI is a trademark of American National Standards Institute, Inc.

AC CABLE											
MINIMUM EXTERNAL DIAMETER OF ARMOR IN INCHES											
Type Of Armored Cable	Type Of Circuit Conductor	AWG Size Of Circuit Conductors	Cable with Two Circuit Conductors and No Grounding Conductor		Cable with Three Circuit Conductors and No Grounding Conductor and Cable with Two Circuit Conductors and a Grounding Conductor		Cable with Four Circuit Conductors and No Grounding Conductor and Cable with Three Circuit Conductors and a Grounding Conductor		Cable with Four Circuit Conductors and a Grounding Conductor		
			Solid	Stranded	Solid	Stranded	Solid	Stranded	Solid	Stranded	
ACTMM	THHN	14	0.433		0.453		0.486		0.522		
		12	0.467		0.489		0.520		0.545		
		10	0.476		0.500		0.541		0.587		
		8	0.570	0.604	0.601	0.637	0.654	0.695	0.714	0.759	
		6		0.700	0.739			0.807		0.882	
		4		0.836	0.885			0.970		1.066	
		2		0.956	1.014		1.115		1.228		



# The CADDY® Fastener Story

## QUALITY CONTROL

CADDY Fasteners, manufactured by ERICO®, are produced from spring steel, galvanized steel, plastic, as well as other materials. We are known in the industry as a leader in the design and production of spring steel fasteners. The following is the story of how we manufacture these quality spring steel fasteners.

## MANUFACTURING

The steel for CADDY Fasteners is procured in mill lots to AISI and ERICO Standards; other materials are equally controlled.

## LOAD RATING

CADDY Fasteners are designed with two load limits:

- 1) **Static load limit** is a rated stationary load limit for a fastener. ERICO Standards require that test samples withstand a load equal to three times this catalog rating.
- 2) The **ultimate static load limit** is the rated stationary load limit which, if exceeded, may cause failure of the fastener. ERICO Standards require that test samples withstand this catalog rating. Some CADDY Fasteners also are designed with an undefined rating and are to be used for positioning only with no loading on them.
- 3) Applications and load ratings may change without notice. Refer to instruction sheet in box or contact ERICO for current load and application information.

Static load limit and ultimate static load limit values specify maximum allowable installed loads for user applications. These values are for loads applied VERTICALLY to the normal fastener installation except as may be diagrammed otherwise. Where the load rating of the CADDY Fastener exceeds that of the structural member, the lowest rated item must set the load limit.

**NOTE:** CADDY Fasteners are intended for support of electrical components at stationary loads. Not to be used for dynamic loads such as fluid and gas distribution components, etc.

## IMPORTANT

CADDY Fasteners used with wire, rod, or threaded rod are designed for use with coarse round wire, hot rolled carbon steel bar, cold rolled carbon steel bar and threaded rod all meeting AISI specifications and tolerances.

## QUALITY ASSURANCE

Incoming steel is sampled and inspected for conformance to AISI specifications and ERICO Standards. Test fixtures and procedures for development and quality control are designed to simulate normal field applications. Fasteners are tested, on a sample basis, to ERICO Standards by certified inspectors. Testing of specific quantities of fasteners to destruction in special statistical audits ensures a continuous high level of quality.

# The CADDY® Fastener Story

## HEAT TREATING

CADDY® Spring Steel Fasteners are heat treated in modern shaker hearth furnaces. Precision controls maintain heat treat operations within the established limits developed by ERICO® for CADDY Fasteners. ERICO Standards incorporate consideration of fastener material and application.

CADDY Fasteners are conveyed directly from the high temperature furnace to the quench tank, through a cleaning cycle and into the tempering furnace. The complete heat treat cycle is automatically controlled.

## PRODUCTION PRESSES

CADDY Fasteners are produced with modern presses and precision tooling. Presses and tools are designed for close tolerance stamping.

## RESEARCH AND DEVELOPMENT

ERICO Research and Development department is constantly working on new fasteners and, at the same time, improving the present line. Starting with six basic fasteners, the line now has several hundred basic types. The majority of the CADDY Fastener line is the result of ERICO development of fasteners to provide a solution for a customer's problem.

**NOTE:** Special applications not specified **MUST** be submitted to ERICO for engineering approval and load rating.

All cULus Listed CADDY fasteners meet the requirements of one of the following UL standards: UL1565, UL2239 or UL514B.

## Materials/Coatings

CADDY Fasteners, manufactured by ERICO, are produced from a number of different materials and coatings to accommodate different applications and environments. Among the materials included are low carbon steel, spring steel, malleable iron, aluminum and stainless steel. Protective coatings are available in five basic zinc coatings: zinc phosphate, zinc electroplate, pre-galvanized zinc, mechanical galvanized zinc, hot dipped galvanized and CADDY® ARMOUR.

CADDY® ERISTRUT comes in the following finishes: aluminum, chromate (California) gold, copper, electro galvanized zinc plated, green, hot dip galvanized, pre-galvanized, plain steel, plastic, and stainless steel.

## MATERIALS

### *Spring Steel*

Spring steel provides light weight fasteners with high gripping power. These fasteners are designed to support a wide range of products from or to a variety of support members. These fasteners are fabricated from high carbon, annealed, spring steel.

**NOTE:** Spring Steel CADDY Fasteners are designed for indoor and non-corrosive environments. Not to be used in certain areas such as over indoor pools, etc.





# The CADDY® Fastener Story

## MATERIALS (continued)

### *Malleable Iron*

ANSI/ASTM A 47-77, Grade 32510, annealed.

### *Aluminum (AL)*

Aluminum provides a high strength to weight ratio that improves ease of use for reduced installation costs, is nonmagnetic and provides good corrosion resistance in a variety of environments. The aluminum selected is designed to meet the fastener manufacturing process and the intended application to meet the loads as specified.

Aluminum products are recommended for indoor and outdoor applications. They may also be used in select corrosive environments.

### *Stainless Steel (SS)*

AISI Type 302 or Type 304 (as noted). Type 316 is available on special request for fasteners as noted.

The above stainless steels belong to the austenitic group and provide many desirable properties including high ambient temperature resistance, corrosion resistance, stable structural properties and are nonmagnetic.

Stainless steel products are recommended for indoor and outdoor applications. They are also recommended for corrosive environments; dependent on the grade of stainless steel.

## COATINGS

### *Zinc Electroplate, Electrogalvanized (EG)*

ANSI/ASTM B633

This corrosion protective coating is applied after the fabrication of steel or malleable iron parts and uses an electrolytic plating process that deposits zinc up to 0.5 mils. A second passivation coating of chromate is then applied for additional protection.

Zinc electroplate products are recommended for indoor and mildly corrosive applications.

### *Zinc Phosphate (ZP)*

This is the coating system generally used on CADDY spring steel fasteners. It is a two coating system, where the first coating of crystalline zinc phosphate, of over 1000 milligrams per square foot, is designed to increase the adhesion of the second coating. The second coating consists of a synthetic, organic corrosion inhibitor with a particular affinity for zinc compounds. ERICO rates this fastener finish at 30 hours. Salt spray testing is in accordance with ASTM B117-61, Federal Test Number QQM-151.

**NOTE:** Black Spring Steel CADDY Fasteners are designed for indoor and non-corrosive environments. Not to be used in certain areas such as over indoor pools, etc. Other finishes are used and may be suitable for indoor and outdoor applications where EMT conduit is used.

# The CADDY® Fastener Story

## *Pre-galvanized Zinc (PG)*

ANSI/ASTM A 525 and 526

Pregalvanized zinc is produced by continuously rolling steel coils or sheets through molten zinc at the mills. The coils or sheets are slit to size and fabricated by forming, shearing or punching to produce the finished product. During fabrication cut edges are not generally zinc coated; however, the zinc near the uncoated metal becomes a sacrificial anode to protect the bare areas.

Pregalvanized zinc products are generally recommended for indoor use on mildly corrosive environments.

## *Mechanical Galvanized Zinc (EPZ)*

ASTM B 695 -90

Mechanical galvanized zinc is a method of depositing zinc using mechanical forces. The resulting layer of zinc is approximately 1 mil (25 microns), is passivated with clear chromate and then sealed with a transparent sealer.

Mechanical galvanized zinc products are recommended for indoor, outdoor and mildly corrosive environments.

## *Hot Dipped Galvanized Zinc (HDG)*

ASTM A123

After a product has finished its fabrication process, it is dipped into a bath of molten zinc. The zinc completely coats all edges and surfaces. Zinc thickness is controlled by the time the part is immersed in the molten zinc bath.

Hot dipped galvanized zinc products are recommended for indoor, outdoor and mildly corrosive environments.

**IMPORTANT:** For more detailed information on a specific product, application or application environment, please contact ERICO Engineering.

## **CADDY® ARMOUR**

The CADDY® ARMOUR coating system features bi-metallic corrosion protection with an inorganic basecoat for sacrificial protection and an organic topcoat for barrier protection. The ERICO® standard for CADDY ARMOUR includes at least 1,000 hours resistance against red rust when tested per the ASTM B117, DIN 50021, or ISO/R 1456 salt spray tests.

The CADDY ARMOUR manufacturing line is optimized to control heat energy, thereby minimizing fossil fuel use. Our energy-efficient coating process minimizes waste by reusing coatings in the process, rather than by burning off excess coatings, into the air. The entire coating process has been designed with a waste minimization approach, which allows the reuse of water and process streams.

CADDY® ARMOUR is RoHS compliant.

\*Note : Spring steel fasteners are for indoor use in non-corrosive environments. Mild steel fasteners can be used outdoors in humid or mildly corrosive environments. Not to be used in certain areas such as over indoor pools, etc.



# Index

2B15LS	170	4Z34	21	8D15L	165
2BR8	144	4Z348P	21	8P	12
2BR12	144	4Z3412P	21	8P4I	12
2BR20	144	4Z3416M	21	8P8P	22
2BR32	144	4Z3416P	21	8P12P	22
2BRT8	144	4Z34812M	21	8P16P	22
2BRT12	144	6A	174	8P24	15
2BRT20	144	6A24	48,84	8P24SM	15
2BRT32	144	6A58	48,84	8P58	15
2EBN	85	6A912	48,84	8P58SM	15
2FMP28	142	6AB	82	8P912	15
2G9	163	6AFAB3	83	8P912SM	15
2G9S10	163	6AO	82	8PATA	158
2H4	47	6EBN	85	8PATS	158
4ACS	169	6M	12	8PF	104
4B2LS	170	6M4I	12	12D15L	165
4B15L	170	6M24	16	12P	12
4B15LS	170	6M24SM	17	12P4I	12
4BRT20	144	6M58	16	12P12P	22
4BRT20WS	144	6M58SM	17	12P16P	22
4BRT32	144	6M912	16	12P24	15
4BRT32WS	144	6M912SM	17	12P24SM	15
4BRT64	144	6MATA	158	12P58	15
4EBN	85	6MATS	158	12P58SM	15
4G8	163	6MB18	30	12P912	15
4G8S7	163	6MB18A	30	12P912SM	15
4G8S7WH	163	6MB186	30	12PATA	158
4G8WH	163	6MB1824	30	12PATS	158
4G9	164	6MB1858	30	12PF	104
4G16	164	6MF	104	16D15L	165
4G16H	164	6NJ2438	55	16M	12
4G24	164	6T	174	16M4I	12
4G162	164	6TA24	48,84	16M24	16
4G163	164	6TA58	48,84	16M24SM	17
4G1615	164	6TA912	48,84	16M58	16
4H24	47	6TAFAB3	83	16M58SM	17
4H58	47,176	6TB	82	16M912	16
4H912	47	6TI	174	16M912SM	17
4J2438	55	6TI24	31,48,84	16MATA	158
4J2438S	55	6TI58	31,48,84	16MATS	158
4LCB	171	6TI912	31,48,84	16MB18	30
4NJ2438	55	6TIAFAB3	83	16MB18A	30
4TGS	164	6TIB	82	16MB186	30
4TI	174	6TIO	82	16MB1824	30
4TI24	48,84	6TO	82	16MB1858	30
4TI58	31,48,84	6W	85	16MF	104
4TI912	48,84	6Z45	21	16P	12
4TIAFAB3	83	6Z34	21	16P4I	12
4TIB	82	6Z348P	21	16P16P	22
4TIO	82	6Z3412P	21	16P24	15
4TW	85	6Z3416M	21	16P24SM	15
4WN	31	6Z3416P	21	16P58	15
4Z45	21	6Z34812M	21	16P58SM	15

# Index

16P912	15	512TC	160	12320M	53
16P912SM	15	515	157	16812M	22
16PATA	158	515A	157	35012P	105
16PATS	158	517A	162	35016M	105
16PF	104	517B	162	35016P	105
20D15L	165	517C	162	51212	160
20M	12	517FCA	162	51220	160
20M4I	12	517FCB	162	51230	160
20M24	16	517FCC	162	52812P	168
20M24SM	17	520	163	52816P	168
20M58	16	528	168	70824	48,84
20M58SM	17	708	174	70858	48,84
20M912	16	708AB	82	122708	53
20M912SM	17	708AFAB3	83	123812M	53
24M	12	708AO	82	350812M	105
24M4I	12	740	176	0502510EG	79
24M24	16	766	103	0503710EG	79
24M24SM	17	766A	103	0505010EG	79
24M58	16	770	166	708912	48,84
24M58SM	17	771	166	2000037EG	62
24M912	16	781	113	2550037EG	57
24M912SM	17	812M	12	2550050EG	57
32M	12	812M4I	12	2550062EG	57
32M4I	12	812M24	16	3000037EG	58
32M24	16	812M24SM	17	3000050EG	58
32M24SM	17	812M58	16	3000062EG	58
32M58	16	812M58SM	17	3000075EG	58
32M58SM	17	812M912	16	3100037EG	58
32M912	16	812M912SM	17	3100050EG	58
32M912SM	17	812MATA	158	3150037EG	59
122	53	812MATS	158	A12A1000GN	66
123	53	812MB18	30	A12A1000PG	66
166M	22	812MB18A	30	A12A2000GN	66
200RS375	75	812MB18S	30	A12A2000PG	66
200RS500	75	812MB186	30	A12AH100PG	66
304B2	101	812MB1824	30	A12AH200GN	66
350	105	812MB1858	30	A12AH200PG	66
449	33	812MF	104	A12H1000CG	66
459	115	1224TI	53	A12H1000GN	66
510HD	161	1226A	53	A12H1000PG	66
510HDTC	161	1226T	53	A12H2000CG	66
512	160	1226TI	53	A12H2000GN	66
512A	160	1236M	53	A12H2000PG	66
512ATC	160	1238P	53	A14H1000CG	66
512HD	161	1616M	22	A14H1000GN	66
512HDEEP	161	1620M	22	A14H1000PG	66
512HDEEPTC	161	1624M	22	A14H2000GN	66
512HDTC	161	1632M	22	A14H2000PG	66
512HDXT	161	3508P	105	A121000PG	66
		5288P	168	A122000GN	66
		12312P	53	A122000PG	66
		12316M	53	A122000PL	66
		12316P	53	AB	174



# Index

AF14	51	BC120000EG	61	CAT21AF14	130
AF144TI	51	BC130025EG	56	CAT21AFAB3	130
AF146A	51	BC130037EG	56	CAT21AFAB4	130
AF146T	51	BC130050EG	56	CAT21AFAB6	130
AF146TI	51	BC130062EG	56	CAT21BC	130
AF14708	51	BC140037EG	56	CAT21BC200	130
AFAB3	83,174	BC140050EG	56	CAT21BC200B	130
AFAB4	174	BC140062EG	56	CAT21BCB	130
AFAB6	174	BC180037EG	76	CAT21CD1B	130
AO	174	BC180050EG	76	CAT21ESC	130
AOL8P	41	BC200000EG	76	CAT21VF14	130
AOL12P	41	BC210000EG	76	CAT32	126
AOL16P	41	BC260025EG	58	CAT32AB	132
AR812	115	BCISN375	45	CAT32AF14	132
ATA4I	158	C4TI24	54	CAT32AFAB3	132
ATS4I	158	C4TI58	54	CAT32AFAB4	132
BC	45	C4TI912	54	CAT32AFAB6	132
BC8P	45	C6TI24	54	CAT32BC	132
BC8PSM	45	C6TI58	54	CAT32BC200	132
BC12P	45	C6TI912	54	CAT32BC200B	132
BC12PSM	45	C12H1000CG	66	CAT32BCB	132
BC16A000EG	76	C12H1000GN	66	CAT32CD1B	132
BC16M	45	C12H1000PG	66	CAT32ESC	132
BC16MSM	45	C12H2000GN	66	CAT32HP	124
BC16P	45	C12H2000PG	66	CAT32PLR	136
BC16PSM	45	C14H1000CG	66	CAT32VF14	132
BC17A000EG	76	C14H1000GN	66	CAT48HP	124
BC17D000EG	76	C14H1000PG	66	CAT64	126
BC17PL00EG	76	C14H2000CG	66	CAT64AF14	134
BC20M	45	C14H2000GN	66	CAT64AFAB3	134
BC20MSM	45	C14H2000PG	66	CAT64AFAB4	134
BC23A000EG	78	C2416SM	54	CAT64AFAB6	134
BC24M	45	C5816SM	54	CAT64BC	134
BC24MSM	45	C24812SM	54	CAT64BC200	134
BC32M	45	C58812SM	54	CAT64BC200B	134
BC32MSM	45	C91216SM	54	CAT64BCB	134
BC200	46	C912812SM	54	CAT64CD1B	134
BC200CD0B	46	CAT12	126	CAT64HP	124
BC200CD1B	46	CAT12AB	128	CAT64PLR	136
BC200CD2.5B	46	CAT12AF14	128	CAT64VF14	134
BC200CD2B	46	CAT12AFAB3	128	CAT100CM	140
BC200CD3B	46	CAT12BC	128	CAT124Z34	128
BC200CD4B	46	CAT12BC200	128	CAT126Z34	128
BC200CD5B	46	CAT12BC200B	128	CAT200CM	140
BC400	46	CAT12BCB	128	CAT200CMLN	140
BC812M	45	CAT12CD1B	128	CAT214Z34	130
BC812MSM	45	CAT12ESC	128	CAT216Z34	130
BC090900EG	61	CAT12TS	128	CAT300CM	140
BC091200EG	61	CAT12VF14	128	CAT300CMLN	140
BC091500EG	61	CAT16HP	124	CAT324Z34	132
BC100000EG	60	CAT16HPTS	124	CAT326Z34	132
BC101500EG	60	CAT21	126	CAT425	138
BC110000EG	61	CAT21AB	130	CAT425A6	138

# Index

CAT425AF14	138	CATHPA4	124	CM5816M	54
CAT425BC	138	CATHPA6	124	CM24812M	54
CAT425BC200	138	CATHPAF14	124	CM58812M	54
CAT425VF14	138	CATHPAN	124	CM91216M	54
CAT425WM	138	CATHPBC	124	CM912812M	54
CAT425WMCD1B	138	CATHPBC200	124	CNB8P	41
CAT600R	137	CATHPBC200B	124	CNB12P	41
CAT600RKIT	137	CATHPBCB	124	CNB812M	41
CAT600WM	137	CATHPCD0B	124	CONC122000PG	66
CAT1224	128	CATHPCD1B	124	CS16	99
CAT1224SM	128	CATHPCD2.5B	124	CS812	99
CAT1258	128	CATHPCD2B	124	CS812D	99
CAT1258SM	128	CATHPESC	124	CT128TRK	145
CAT2124	130	CATHPPLR	124	DBM2	102
CAT2124SM	130	CATHP54	124	DH2	87
CAT2158	130	CATHPTM	124	DH4TI	87
CAT2158SM	130	CATHPVF14	124	DH6A	87
CAT3224	132	CATKITA	126	DH6T	87
CAT3224SM	132	CATKITB	126	DH6TI	87
CAT3258	132	CATKITC	126	DH708	87
CAT3258SM	132	CATMTH	146	DSB	118
CAT6424	134	CATMTLS	146	DSI2A	118
CAT6424SM	134	CATMTP	146	EC311	167
CAT6458	134	CATRL200CM	140	EC311P	167
CAT6458SM	134	CATRL300CM	140	EC3114Z34	167
CAT12912	128	CATRT200CM	140	EC3116Z34	167
CAT12912SM	128	CATRT300CM	140	ESC4	80
CAT21912	130	CATTBCM	140	ESC4TI	80
CAT21912SM	130	CATTRAX25	145	ESC6M	80
CAT32912	132	CATTS	126	ESC6TI	80
CAT32912SM	132	CATWMCM	140	ESC8P	80
CAT42524SM	138	CCS812	108	ESC12P	80
CAT42558SM	138	CD0B	14	ESC812M	80
CAT64912	134	CD1B	14	ESG1	114,153
CAT64912SM	134	CD2.5B	14	ESG1M	114,153
CAT425912SM	138	CD2B	14	ESGP	114,153
CATCR50	147	CD3B	14	ESGPM	114,153
CATHBA	126	CD4B	14	ET0050HD	63
CATHBA3	126	CD5B	14	ET0075HD	63
CATHBA6	126	CD6B	14	ET0100HD	63
CATHBA8	126	CD7B	14	ET0125HD	63
CATHP4Z34	124	CD8B	14	ET0150HD	63
CATHP6Z34	124	CD9B	14	ET0200HD	63
CATHP24	124	CG4	111,143	ET0250HD	63
CATHP24SM	124	CHB	160	ET0300HD	63
CATHP58	124	CHBTC	160	F140000EG	79
CATHP58SM	124	CJ6	112	F150000EG	79
CATHP912	124	CJ6IN	112	FB6M	115
CATHP912SM	124	CJ6S	112	FB8P	115
		CM245	54	FB12P	115
		CM585	54	FB812M	115
		CM9125	54	FBS12	108
		CM2416M	54	FBS16	108



# Index

FBS18	108	M58S	49	MF625	104
FMBS18	109	M912	49	MF750	104
FXC20	113	M912S	49	MFA4I	69,175
H4	98	MAC2	26	MFA625	69,175
H6	98	MAC2AO	26	MFI	104
H23	98	MAC2ATA	26	MFO	104
H23TC	98	MAC2BC	26	MFS	104
H46TC	98	MAC2FB	26	MP1	121,151
HMZE215	178	MAC2T	26	MP1P	120,152
HMZE220	178	MAC2VF14	26	MP1S	110,150
HMZE240	178	MAC24Z34	26	MP2S	110,150
HMZE340	178	MAC26Z34	26	MP34P	120,152
HMZE350	178	MAC224	26	MPAL2	120,152
HMZG160	178	MAC224SM	26	MPLS	121,151
HMZG315	178	MAC258	26	MPLS2	121,151
HMZG365	178	MAC258SM	26	MPVTI	119
HMZG471	178	MAC2123	26	MSF	102
HMZG550	178	MAC2912	26	MSP20	114,153
HMZG660	178	MAC2912SM	26	MSR24	89
HMZG730	178	MCS50	34	MSR58	89
HMZH455	178	MCS50AF14	34	MSR912	89
HMZH475	178	MCS50BC	34	MSRBC200	89
HMZH476	178	MCS50BC200	34	MSS24	89
HMZH665	178	MCS50VF14	34	MSS58	89
HRL15A	170	MCS100	34	MSS912	89
HS3	98	MCS100AF14	34	MSSAFAB3	89
IDS	159	MCS100BC	34	MSSBC200	89
IDS2	159	MCS100BC200	34	NUT0025EG	69
IDS9	159	MCS100VF14	34	NUT0031EG	69
IDS9T	159	MCS101	34	NUT0037EG	69
IDS15	159	MCS101AF14	34	NUT0050EG	69
IDS95	159	MCS101BC	34	NUT0062EG	69
IDS95T	159	MCS101BC200	34	NUT0075EG	69
IDST	159	MCS101VF14	34	PAR0050HD	63
INC8T5	78	MCS504Z	34	PAR0075HD	63
ISN375	86	MCS506Z	34	PAR0100HD	63
ISSP375	86	MCS1004Z	34	PAR0125HD	63
ISSPK	86	MCS1006Z	34	PAR0150HD	63
J1A35	103	MCS1014Z	34	PAR0200HD	63
K8	19	MCS1016Z	34	PAR0250HD	63
K12	19	MCS5024	34	PAR0300HD	63
K16	19	MCS5058	34	PAR0037HD	63
K20	19	MCS10024	34	PAR0350HD	63
KX	19	MCS10058	34	PAR0400HD	63
LCSB12	172	MCS10124	34	PCS1	20
LFC	166	MCS10158	34	PCS2	20
LFC90	166	MCS50912	34	PH4	52
LI1	149	MCS100912	34	PH6	52
LI2	149	MCS101912	34	PHSW4	52
LTGH	171	MEB1	100	PHSW6	52
M24	49	MF250	104	PPRPS25H4	38
M24S	49	MF375	104	PPRPS25H6	38
M58	49	MF500	104	PT16	165

# Index

PT16FP	165	S3575DP100	127,177	SCMKW	148
PT16SPCR	165	S102438BP50	160	SFCLT	156
RA0050HD	63	SBT18	36	SFCLTCF	156
RA0075HD	63	SBT18BC	36	SFCLTCFS	156
RA0100HD	63	SBT18BC200	36	SFCLTE	156
RA0125HD	63	SBT184Z34	36	SFCLTS	156
RA0150HD	63	SBT186Z34	36	SGB16A	107
RA0200HD	63	SBT1824	36	SGB24A	107
RA0250HD	63	SBT18245M	36	SK8ALA	24
RA0300HD	63	SBT1858	36	SK12ALA	24
RA0037HD	63	SBT18585M	36	SK16ALA	24
RA0350HD	63	SBT18912	36	SK20ALA	24
RA0400HD	63	SBT189125M	36	SK24ALA	24
RBS16	106	SC2A	32	SK32ALA	24
RBS24	106	SC2B	32	SK40ALA	24
RGC	177	SC2C	32	SK48ALA	24
RIGD0050XX	25,72	SC2D	32	SK56ALA	24
RIGD0075XX	25,72	SC2E	32	SK64ALA	24
RIGD0100XX	25,72	SC2F	32	SK85I	24,74
RIGD0125XX	25,72	SC2G	32	SK125I	24,74
RIGD0150XX	25,72	SC4A	32	SK165I	24,74
RIGD0200XX	25,72	SC4B	32	SK205I	24,74
RIGD0250XX	25,72	SC4C	32	SK245I	24,74
RIGD0300XX	25,72	SC4D	32	SK325I	24,74
RIGD0350XX	25,72	SC4E	32	SK405I	24,74
RIGD0400XX	25,72	SC4F	32	SK485I	24,74
RLC	119	SC4G	32	SK565I	24,74
RMX	28	SC8A	32	SK645I	24,74
RMX4Z34	28	SC8B	32	SL1214	94
RMX6Z34	28	SC8C	32	SL1518	94
RMX24	28	SC8D	32	SLADCP	94
RMX58	28	SC8E	32	SLADS	94
RMX912	28	SC8F	32	SLD2L1	91
RMXAB	28	SC8G	32	SLD2L1BP	91
RMXAF14	28	SCH6B	23,73	SLD2L2	91
RMXAO	28	SCH8	23,73	SLD2L2BP	91
RMXATS	28	SCH8B	23,73	SLD2L3	91
RMXBC	28	SCH12	23,73	SLD2L3BP	91
RMXDH2	28	SCH12B	23,73	SLD2L5	91
RMXVF14	28	SCH16	23,73	SLD2L5BP	91
RPS50AHSV	38	SCH16B	23,73	SLD2L7	91
RPS50H4EG	38	SCH20	23,73	SLD2L10	91
RPS50H6EG	38	SCH20B	23,73	SLD2L10BP	91
RPS150T1	39	SCH24B	23,73	SLD2Y300	91
RPS150T2	39	SCH32B	23,73	SLD2Y300L2	91
RPS300T1	39	SCH40B	23,73	SLD2Y300L3	91
RPS300T2	39	SCH48B	23,73	SLD2Y300L5	91
RPS600T2	40	SCH56B	23,73	SLD2Y300L7	91
S3575BP100	127,177	SCH64B	23,73	SLD2Y300L10	91
		SCH72B	23,73	SLD2Y500	91
		SCMKB	148	SLD2Y500L3	91
		SCMKC	148	SLD2YH500	91
		SCMKT	148	SLD2YH500L2	91





# Index

SLD2YH500L2TP91		SLD15Y800TP	93
SLD2YH500L3	91	SLEB250	94
SLD2YH500L3TP91		SLEB375	94
SLD2YH500L7	91	SLEBM6	94
SLD2YH500L7TP91		SLEBM8	94
SLD2YH800	91	SLEBWS	94
SLD3L1	91	SLICK250	70
SLD3L1BP	91	SLICK375	70
SLD3L2	91	SLICK500	70
SLD3L2BP	91	SLLC250	94
SLD3L2SS	91	SLWC	94
SLD3L3	91	SLWPT	94
SLD3L3BP	91	SMS8	116,177
SLD3L3SS	91	SPRA0037EG	69
SLD3L5	91	SPRA0050EG	69
SLD3L5BP	91	SPRC0025EG	69
SLD3L7	91	SPRC0050EG	69
SLD3L10	91	SPRD0025EG	69
SLD3L10BP	91	SPRD0037EG	69
SLD3YH500	91	SPRD0050EG	69
SLD3YH800	91	SPRD0062EG	69
SLD15L1	93	SPRD0075EG	69
SLD15L1T	93	SPRM2508EG	69
SLD15L1TP	93	SPRM2511EG	69
SLD15L1TTP	93	SPRM3711EG	69
SLD15L2	93	SPRM5011EG	69
SLD15L2S	93	SPRM5013EG	69
SLD15L2T	93	STCB6	75
SLD15L2TP	93	STS	71
SLD15L2TTP	93	TDH	88
SLD15L3	93	TDHP2	88
SLD15L3T	93	TDHP2PR10	88
SLD15L3TP	93	TDHT4	88
SLD15L3TTP	93	TDHT6	88
SLD15L5	93	TGE	157
SLD15L5S	93	TSGB16	107
SLD15L5T	93	TSGB24	107
SLD15L5TP	93	TSNT0025EG	69
SLD15L5TTP	93	TSNT0037EG	69
SLD15L7	93	TSNT0050EG	69
SLD15L7T	93	VAFT	50,95
SLD15L10	93	VF14	50
SLD15L10S	93	VF144TI	50
SLD15L10T	93	VF146A	50
SLD15L10TTP	93	VF146T	50
SLD15QT250	93	VF146TI	50
SLD15Y200	93	VF14708	50
SLD15Y300	93	WC812	13
SLD15Y300L3	93	WMX3	33
SLD15Y300L5	93	WMX6	33
SLD15Y500	93		
SLD15Y500TP	93		
SLD15Y800	93		

#### WARNING

ERICO products shall be installed and used only as indicated in ERICO's product instruction sheets and training materials. Instruction sheets are available at [www.erico.com](http://www.erico.com) and from your ERICO customer service representative. Improper installation, misuse, misapplication or other failure to completely follow ERICO's instructions and warnings may cause product malfunction, property damage, serious bodily injury and death.

#### WARRANTY

ERICO products are warranted to be free from defects in material and workmanship at the time of shipment. NO OTHER WARRANTY, WHETHER EXPRESS OR IMPLIED (INCLUDING ANY WARRANTY OF MERCHANTABILITY OR FITNESS FOR A PARTICULAR PURPOSE), SHALL EXIST IN CONNECTION WITH THE SALE OR USE OF ANY ERICO PRODUCTS. Claims for errors, shortages, defects or nonconformities ascertainable upon inspection must be made in writing within 5 days after Buyer's receipt of products. All other claims must be made in writing to ERICO within 6 months from the date of shipment or transport. Products claimed to be nonconforming or defective must, upon ERICO's prior written approval in accordance with its standard terms and procedures governing returns, promptly be returned to ERICO for inspection. Claims not made as provided above and within the applicable time period will be barred. ERICO shall in no event be responsible if the products have not been stored or used in accordance with its specifications and recommended procedures. ERICO will, at its option, either repair or replace nonconforming or defective products for which it is responsible or return the purchase price to the Buyer. THE FOREGOING STATES BUYER'S EXCLUSIVE REMEDY FOR ANY BREACH OF ERICO WARRANTY AND FOR ANY CLAIM, WHETHER SOUNDING IN CONTRACT, TORT OR NEGLIGENCE, FOR LOSS OR INJURY CAUSED BY THE SALE OR USE OF ANY PRODUCT.

#### LIMITATION OF LIABILITY

ERICO excludes all liability except such liability that is directly attributable to the willful or gross negligence of ERICO's employees. Should ERICO be held liable its liability shall in no event exceed the total purchase price under the contract. ERICO SHALL IN NO EVENT BE RESPONSIBLE FOR ANY LOSS OF BUSINESS OR PROFITS, DOWNTIME OR DELAY, LABOR, REPAIR OR MATERIAL COSTS OR ANY SIMILAR OR DISSIMILAR CONSEQUENTIAL LOSS OR DAMAGE INCURRED BY BUYER.

ANSI is a trademark of American National Standards Institute, Inc.

ASTM is a trademark of ASTM International

cUL is a registered trademark of Underwriters Laboratories of Canada (UL Canada).

cULus is a registered trademark of Underwriters Laboratories, Inc.

ETL and Warnock Hersey are registered certification marks of ETL Semko.

The Canadian Electric Code is a copyright of The Canadian Standards Association International.

Canadian Electric Code (CEC) is a registered trademark of The Canadian Standards Association International.

ICBO standards are a copyright of the International Code Council.

ICC is a registered trademark of the International Code Council.

The National Electric Code is a copyright of The National Fire Protection Association.

National Electric Code (NEC) is a registered trademark of The National Fire Protection Association.

TIA is a registered service mark of the Telecommunications Industry Association.

UL is a registered trademark of Underwriters Laboratories, Inc.





ERICO® is a leading designer, manufacturer and marketer of precision-engineered specialty metal products serving global niche product markets in a diverse range of electrical, construction, utility and rail applications. The company is headquartered in Solon, Ohio, USA with a network of sales locations serving more than 25 countries and with manufacturing and distribution facilities worldwide. ERICO's well-known brand names include: CADDY® fixings, fasteners and supports; CADWELD® welded electrical connections; CRITEC® surge protection devices; ERICO® rail bonds and specialty products; ERIFLEX® low-voltage panel components; ERITECH® electrical products; and LENTON® concrete reinforcement. Visit ERICO online at [www.erico.com](http://www.erico.com).

1  
2  
3  
4  
5  
6  
7  
8  
9  
10  
11  
12  
13  
14  
15  
16  
17  
18  
19  
20

# ERICO®



[www.erico.com](http://www.erico.com)



**AUSTRALIA**

Phone +61-2-9751-8500  
Fax +61-2-9475-5334



**CHINA**

Phone +86-21-3430-4878  
Fax +86-21-5831-8177



**HUNGARY**

Phone +068-00-165-38  
Fax +31-13-583-5499



**NORWAY**

Phone +800-100-73  
Fax +800-100-66



**SWITZERLAND**

Phone +0800-558-697  
Fax +0800-559-615



**BELGIUM**

Phone +0800-757-48  
Fax +0800-757-60



**DENMARK**

Phone +808-89-373  
Fax +808-89-372



**INDONESIA**

Phone +62-21-575-0941  
Fax +62-21-575-0942



**POLAND**

Phone +48-71-374-4022  
Fax +48-71-374-4043



**THAILAND**

Phone +66-2-267-5776  
Fax +66-2-636-6988



**BRAZIL**

Phone +55-11-3623-4333  
Fax +55-11-3621-4066



**FRANCE**

Phone +33-4-77-365-656  
Fax +33-4-77-553-789



**ITALY**

Phone +39-02-8474-2250  
Fax +39-02-8474-2251



**SINGAPORE**

Phone +65-6-268-3433  
Fax +65-6-268-1389



**UNITED ARAB  
EMIRATES**

Phone +971-4-881-7250  
Fax +971-4-881-7270



**CANADA**

Phone +1-800-677-9089  
Fax +1-800-677-8131



**GERMANY**

Phone +0-800-189-0272  
Fax +0-800-189-0274



**MEXICO**

Phone +52-55-5260-5991  
Fax +52-55-5260-3310



**SPAIN**

Phone +34-93-467-7726  
Fax +34-93-467-7725



**UNITED KINGDOM**

Phone +0808-2344-670  
Fax +0808-2344-676



**CHILE**

Phone +56-2-370-2908  
Fax +56-2-370-2914



**HONG KONG**

Phone +852-2764-8808  
Fax +852-2764-4486



**NETHERLANDS**

Phone +31-13-583-5400  
Fax +31-13-583-5499



**SWEDEN**

Phone +0207-909-08  
Fax +0207-989-64



**UNITED STATES**

Phone +1-440-248-0100  
Fax +1-440-248-0723